

TX-28/25/21MD3F Service Manual

Safety

Specifications

Parts List

Service
Information

Adjustments

Self Check

Service Hints

Mechanical
View

Disassembly

Location of
Controls

Waveforms

Block Diagrams

Schematic Diagrams

PCB Views

Service Support

Service and repair of this product is supported by Panasonic's LUCI interface.

This interface provides a link between the TV and a standard PC to allow a number of diagnostic and control functions to be performed.

For more details contact your local Panasonic company.

BACK

EXIT

Video / Audio

Control

BACK

B - PCB

E - PCB

Y - PCB

B - Schematic

E - Schematic

P - Schematic

Y - Schematic

BACK

BACK

Service Manual



Colour Television

TX-28MD3F

TX-25MD3F

TX-21MD3F

EURO-2M Chassis

SPECIFICATIONS

(Information in brackets {} refer to TX-25MD3F)
(Information in brackets [] refer to TX-21MD3F)

Power Source : 220-240V AC, 50Hz
Power Consumption : 94W, {92W}, [75W]
Standby Power Consumption : 1W
Aerial Impedance : 75Ω unbalanced, Coaxial Type
Receiving System : PAL-BG, H, PAL 60,
 SECAM BG, L/L'
 MNTSC, NTSC (AV Only)

Receiving Channels :
 VHF E2 – E12 VHF H1 – H2 (ITALY)
 VHF A – H (ITALY) VHF R1 – R2
 VHF R3 – R5 VHF R6 – R12
 UHF E21 – E69 CATV (S01 – S05)
 CATV S1 – S10 (M1 – M10) CATV S11 – S20 (U1 – U10)
 CATV S21 – S41 (HYPERBAND)

Intermediate Frequency :
 Video 38.9 MHz, 34 MHz
 Sound 33.4 MHz, 33.16 MHz,
 32.4 MHz, 33.05 MHz, 40.4 MHz
 Colour 34.47 MHz, 34.5 MHz 34.65 MHz

Video / Audio Terminals :

AUDIO MONITOR OUT	Audio(RCA x 2)	500mVrms, 1kΩ
AV1 IN	Video (21 pin)	1V p-p 75Ω
	Audio (21 pin)	500mV rms 10kΩ
	RGB (21 pin)	
AV1 OUT	Video (21 pin)	1V p-p 75Ω
	Audio (21 pin)	500mV rms 1kΩ
AV2 IN	Video (21 pin)	1V p-p 75Ω
	Audio (21 pin)	500mV rms 10kΩ
	S-Video IN	Y : 1 Vp-p 75Ω
	(21 pin)	C : 0.3 Vp-p 75Ω
AV2 OUT	Video (21 pin)	1V p-p 75Ω
	Audio (21 pin)	500mV rms 1kΩ
AV3 IN	Audio (RCA x 2)	500mV rms, 10kΩ
	Video (RCA x 1)	1 Vp-p 75Ω

High Voltage : 28kV ± 1kV
 (zero beam current) {28kV ± 1kV}
 [27kV ± 1kV]

Picture Tube : A66ECF50X32 66 cm
 {A59ECF50X32 59 cm}
 [A51ECQ51X01 51 cm]

Audio Output : 15 W (Music Power)
 Speaker 8 Ω Impedance

Headphones 8 Ω Impedance

Accessories supplied : Remote Control
 2 x R6 (UM3) Batteries

Dimensions :
 Height : 576 mm {535 mm} [481 mm]
 Width : 472 mm {440 mm} [477 mm]
 Depth : 666 mm {601 mm} [525 mm]
Net Weight : 31kg {26kg} [22kg]

Specifications are subject to change without notice.
 Weight and dimensions shown are approximate.

TECHNISCHE DATEN

(Werte in Klammern gelten {} nur für TX-25MD3F)
(Werte in Klammern gelten [] nur für TX-21MD3F)

Netzspannung : 220-240V AC, 50Hz
Leistungsaufnahme : 94W, {92W}, [75W]
Standby Leistungsaufnahme : 1W
Antennenimpedanz : 75Ω asymmetrisch, Koaxial – Typ
Empfangssystem : PAL-BG, H, PAL 60,
 SECAM BG, L/L'
 MNTSC, NTSC (nur AV Eingang)

Empfangsbereiche :
 VHF E2 – E12 VHF H1 – H2 (ITALY)
 VHF A – H (ITALY) VHF R1 – R2
 VHF R3 – R5 VHF R6 – R12
 UHF E21 – E69 CATV (S01 – S05)
 CATV S1 – S10 (M1 – M10) CATV S11 – S20 (U1 – U10)
 CATV S21 – S41 (HYPERBAND)

Zwischenfrequenz :
 Video 38.9 MHz, 34 MHz
 Sound 33.4 MHz, 33.16 MHz,
 32.4 MHz, 33.05 MHz, 40.4 MHz
 Colour 34.47 MHz, 34.5 MHz 34.65 MHz

Video / Audio Anschlüsse :

AUDIO MONITOR AUSGANG	Audio(RCA x 2)	500mVrms, 1kΩ
AV1 EINGANG	Video (21 pin)	1V p-p 75Ω
	Audio (21 pin)	500mV rms 10kΩ
	RGB (21 pin)	
AV1 AUSGANG	Video (21 pin)	1V p-p 75Ω
	Audio (21 pin)	500mV rms 1kΩ
AV2 EINGANG	Video (21 pin)	1V p-p 75Ω
	Audio (21 pin)	500mV rms 10kΩ
	S-Video IN	Y : 1 Vp-p 75Ω
	(21 pin)	C : 0.3 Vp-p 75Ω
AV2 AUSGANG	Video (21 pin)	1V p-p 75Ω
	Audio (21 pin)	500mV rms 1kΩ
AV3 EINGANG	Audio (RCA x 2)	500mV rms, 10kΩ
	Video (RCA x 1)	1 Vp-p 75Ω

Hochspannung : 28kV ± 1kV
 (bei Nullstrahlstrom) {28kV ± 1kV}
 [27kV ± 1kV]

Bildrohre : A66ECF50X32 66 cm
 {A59ECF50X32 59 cm}
 [A51ECQ51X01 51 cm]

Ton Ausgangsleistung : 15 W (Musikleistung)
Lautsprecher 8 Ω Impedanz

Kopfhörer 8 Ω Impedanz

Mittel. Zubehör : Fernbedienung
 2 x R6 (UM3) Batterien

Abmessungen :
 Höhe : 576 mm {535 mm} [481 mm]
 Breite : 472 mm {440 mm} [477 mm]
 Tiefe : 666 mm {601 mm} [525 mm]
Gewicht : 31kg {26kg} [22kg]

Änderungen der technischen Daten vorbehalten.
 Gewichte und Abmessungen sind Näherungsangaben.

Panasonic

CONTENTS

- SAFETY PRECAUTIONS
- SERVICE HINTS
- SERVICE MODE
- ADJUSTMENT PROCEDURE
- SELF CHECK
- ALIGNMENT SETTINGS
- WAVEFORM PATTERN TABLE
- BLOCK DIAGRAMS
- PARTS LOCATION
- REPLACEMENT PARTS LIST
- CONDUCTOR VIEWS
- SCHEMATIC DIAGRAMS

SAFETY PRECAUTIONS

GENERAL GUIDE LINES

1. It is advisable to insert an isolation transformer in the AC supply before servicing a hot chassis.
2. When servicing, observe the original lead dress in the high voltage circuits. If a short circuit is found, replace all parts which have been overheated or damaged by the short circuit.
3. After servicing, see that all the protective devices such as insulation barriers, insulation papers, shields and isolation R-C combinations are correctly installed.
4. When the receiver is not being used for a long period of time, unplug the power cord from the AC outlet.
5. Potentials as high as 29kV [28kV] are present when this receiver is in operation. Operation of the receiver without the rear cover involves the danger of a shock hazard from the receiver power supply. Servicing should not be attempted by anyone who is not familiar with the precautions necessary when working on high voltage equipment. Always discharge the anode of the picture to the chassis before handling the tube.
6. After servicing make the following leakage current checks to prevent the customer from being exposed to shock hazards.

LEAKAGE CURRENT COLD CHECK

1. Unplug the AC cord and connect a jumper between the two prongs of the plug.
2. Turn on the receiver's power switch.
3. Measure the resistance value with an ohmmeter, between the jumpered AC plug and each exposed metallic cabinet part on the receiver, such as screw heads, aerials, connectors, control shafts etc. When the exposed metallic part has a return path to the chassis the reading should be between 4M ohm and 20M ohm. When the exposed metal does not have a return path to the chassis the reading must be infinite.

INHALT

- SICHERHEITSVORKEHRUNGEN
- SERVICE HINWEISE
- ABGLEICHVERFAHREN
- ABGLEICH
- SELF CHECK
- ABGLEICHTABELLE
- SIGNALE TABELLE
- SCHALTBILD BLOCK
- EXPLOSIONSZEICHNUNG
- ERSATZTEILLISTE
- ANSICHT DER LEITERBAHNEN
- SCHALTBILD SCHEMA

SICHERHEITSVORKEHRUNGEN

ALLGEMEINE RICHTLINIEN

1. Es ist empfehlenswert einen Trenntransformator in die Stromversorgung zu schalten, bevor Reparaturen an einem Gerät vorgenommen werden, dessen Chassis unter Spannung steht.
2. Bei der Durchführung von Servicearbeiten dürfen die ursprünglichen Kabelanschlüsse nicht vertauscht werden. Dies gilt insbesondere für die Anschlüsse im Hochspannungsteil. Hat sich ein Kurzschluß ereignet, dann sind alle Teile, an denen Spuren von Überhitzung sichtbar sind, auszuwechseln.
3. Nach Beenden der Servicearbeiten ist sicherzustellen, daß alle Sicherheitsvorrichtungen, wie Isolationsstege, Isolationspapiere, Abschirmungen und Isolations-R-C-Glieder wieder richtig eingesetzt sind.
4. Wenn der Fernseher während längerer Zeit nicht in Betrieb gesetzt wird, sollte der Netzstecker aus der Netzsteckdose gezogen werden.
5. Im Betrieb sind Spannungen bis zu 29kV [28kV] in diesem Gerät vorhanden. Die Inbetriebnahme des Fernsehers ohne aufgesetzte Rückwand bringt die Gefahr eines elektrischen Schlages von der Fernseher – Stromversorgung mit sich. Servicearbeiten sollten daher auch nie durch Personen versucht werden, die nicht in vollem Umfang mit den Sicherheitsvorkehrungen beim Umgang mit Hochspannungsgeräten vertraut sind. Vor der Handhabung mit der Bildröhre ist die Anode der Bildröhre immer an dem Empfängerchassis zu entladen.
6. Nach Beenden der Servicearbeiten sind die folgenden Kriechstrom-Prüfungen durchzuführen, um den Kunden vor der Gefahr eines elektrischen Schlages zu schützen.

MESSUNG DES ISOLATIONSWIDERSTANDES IM ABGESCHALTETEN ZUSTAND

1. Den Netzstecker aus der Netzsteckdose ziehen und die beiden Steckerstifte kurzschließen.
2. Den Geräteschalter des Fernsehgerätes einschalten.
3. Mit einem Ohmmeter den Widerstandswert zwischen dem überbrückten Netzkabelstecker und jedem zugänglichen Metallteil am Gehäuse des Fernsehgerätes, wie Schraubenköpfe, Antennen, Achsen der Regler, Griffassungen usw. messen. Wenn ein zugängliches Metallteil keine Rückleitung zum Chassis hat, muß die Anzeige unendlich betragen.

LEAKAGE CURRENT HOT CHECK

1. Plug the AC cord directly into the AC outlet. Do not use an isolation transformer for this check.
2. Connect a 2kΩ 10W resistor in series with an exposed metallic part on the receiver and an earth such as a water pipe.
3. Use an AC voltmeter with high impedance to measure the potential across the resistor.
4. Check each exposed Metallic part and check the voltage at each point.
5. Reverse the AC plug at the outlet and repeat each of the above measurements.
6. The potential at any point should not exceed 1.4 Vrms. In case a measurement is outside the limits specified, there is a possibility of a shock hazard, and the receiver should be repaired and rechecked before it is returned to the customer.

MESSUNG DES KRIECHSTROMS IM EINGESCHALTETEN ZUSTAND

1. Den Netzstecker direkt in eine Netsteckdose stecken. Für diese Messung keinen Trenntransformator verwenden.
2. Einen 2k Ω / 10W–Widerstand in Serie mit einem von außen zugänglichen Metallteil am Fernsehgerät und einer guten, Erdung z.B Wasserleitung, anschließen.
3. Ein Wechselstrom–Voltmeter mit einem Meßbereich von 1000 Ohm.Volt oder größer verwenden, um die Spannung über den Widerstand zu messen.
4. Jedes zugängliche Metallteil prüfen, und an jedem Punkt dies Spannung messen.
5. Den Netzstecker umgekehrt in die Steckdose stecken und jede der obigen Messungen wiederholen.
6. Die Spannung darf an keinem der Punkte 1.4V eff. überschreiten. Wird dieser Wert nicht eingehalten, besteht die Gefahr eines elektrischen Schlages, und das Fernsehgerät sollte daher repariert und nachgeprüft werden, bevor es an den Kunden zurückgegeben wird.

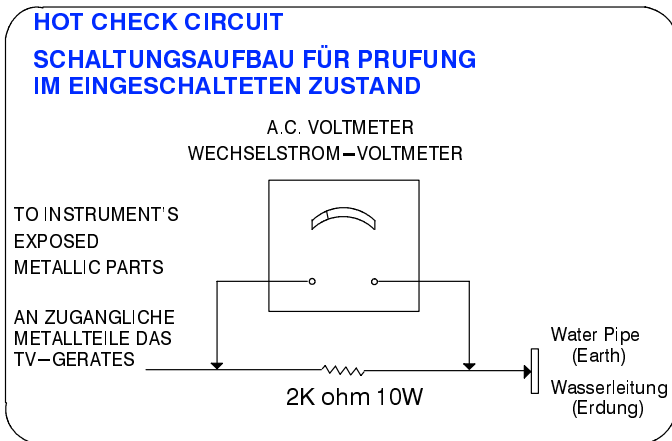

Fig.1.
Abb.1.

X–RADIATION WARNING

1. The potential sources of X–Radiation in TV sets are the high voltage section and the picture tube.
2. When using a picture tube test jig for service ensure that the jig is capable of handling 29kV [28kV] without causing X–Radiation.

NOTE : It is important to use an accurate periodically calibrated high voltage meter

1. Set the brightness to minimum.
2. Measure the high voltage. The meter should indicate 28kV ± 1kV [27kV ± 1kV] if the meter indication is out of tolerance, immediate service and correction is required to prevent the possibility of premature component failure.
3. To prevent any X–Radiation possibility, it is essential to use the specified tube.

RÖNTGENSTRAHLUNG ACHTUNG :

1. Potentielle Quellen von Röntgenstrahlung in Fernsehgeräten sind das Hochspannungsteil und die Bildröhre.
2. Bei Verwendung eines Bildröhren–Prüfgerätes für den Service ist sicherzustellen, daß es für die Belastung von 29kV [28kV] geeignet ist, ohne daß eine Röntgenstrahlung verursacht wird.

ANMERKUNG : Es ist wichtig, daß ein präzises, regelmäßig geprüftes Voltmeter verwendet wird.

1. Helligkeit auf Minimum stellen.
2. Die Hochspannung messen. Die Anzeige des Instrumentes sollte 28kV ± 1kV [27kV ± 1kV] Falls die Anzeige diese Toleranzgrenzen überschreitet, ist die sofortige Behebung nötig, um die Möglichkeit vorzeitigen Komponentenausfalls zu verhüten.
3. Um die Möglichkeit von Röntgenstrahlung zu begrenzen, ist es wichtig, daß nur die vorgeschriebene Bildröhre verwendet wird.

SERVICE HINTS

HOW TO REMOVE THE REAR COVER

1. Remove the 6 screws (A) as shown in **Fig.2/Fig.3.**

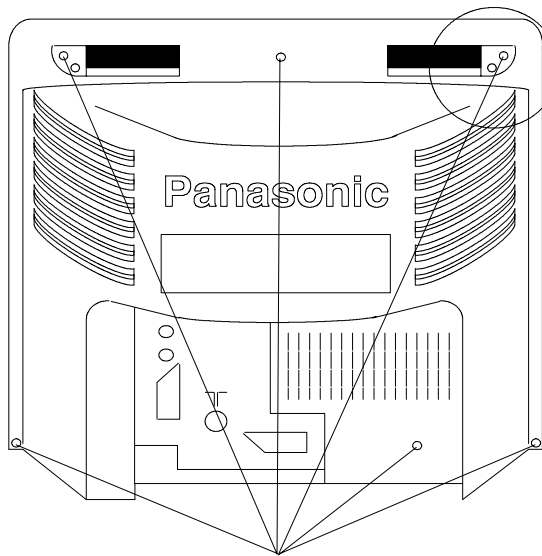

SCREWS A
SCHRAUBEN A

Fig. 2.
Abb. 2.

SERVICE HINWEISE

ENTFERNEN DER GERÄTERÜCKWAND

1. Die 6 Schrauben (A) entfernen, siehe **Abb.2/Abb.3.**

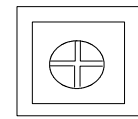

SCREW
SCHRAUBEN

Fig. 3.
Abb. 3.

LOCATION OF CONTROLS

LAGE DER EINSTELLREGLER

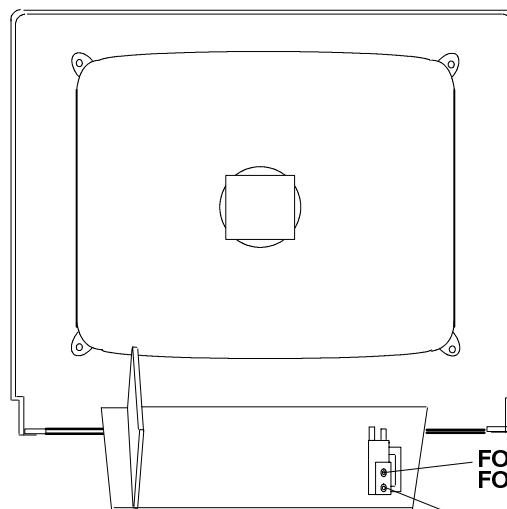

E P.C.B.

FOCUS
FOKUSREGLER

SCREEN
SCHIRMGITTERREGLER

Fig. 4.
Abb. 4.

SERVICE MODE

The remote control is used for entering and storing adjustments, with the exception of cut-off adjustments which must always be done prior to service adjustment. Perform adjustments in accordance with screen display. The display on the screen also specifies the CCU variants as well as the approx. setting values. The adjustment sequence for the service mode is indicated below.

1. Set the Bass to maximum position, set the Treble to minimum position, press the Reveal button on the remote control and at the same time press the Volume down on the customer controls at the front of the TV, this will place the TV into the Service Mode.
2. Press the RED / GREEN buttons to step down / up through the functions.
3. Press the YELLOW / BLUE buttons to alter the function values.
4. Press the STORE button on the preset panel after each adjustment has been made to store the required values.
5. To exit the Service Mode press the Normalisation button.

NOTE: This TV also has the option of using a Memory Pack which enables you to copy the preset TV channels and analogue levels into the Memory Pack and then upload them onto another EURO-2M TV set.

USING THE MEMORY PACK

TV to Memory Pack process

1. Plug the memory pack into the lower of the two 21 pin terminals at the back of the TV and switch the TV on. If the TV has only one 21 pin connector then this will be able to accept the memory pack.
2. Go into the Service Mode as explained above. The screen will show:—

Program
External>>TV

3. Press the blue button on the remote control. The screen will show:—

Program
TV>>External

4. Press the STORE button on the TV. The screen will show:—

Storing

5. All the tuning information stored inside the TV will now be transferred to the Memory Pack. This process will take 2-3 minutes to complete and when finished the screen will show:—

OK!

Memory Pack to TV Process

1. Plug the memory pack into the lower of the two 21 pin terminals at the back of the TV and switch the TV on. If the TV has only one 21 pin connector then this will be able to accept the memory pack.
2. Go into the Service Mode as explained above. The screen will show:—

Program
External>>TV

3. Press the STORE button on the TV. The screen will show:—

Loading

4. All the tuning information stored inside the Memory Pack will now be transferred to the TV. This process will take 2-3 minutes to complete and when finished the screen will show:—

OK!

5. The tuning information from the Memory Pack has now been copied into the TV
6. To exit from the Service Mode switch off the TV.
7. The process has now been completed and the Memory Pack can now be removed.

Errors

If an error occurs while using the Memory Pack the TV will detect this and the screen will show:—

Program
Error!

If this happens then switch off the TV and repeat the process that was being used. If the errors continue to occur then check the connectors between the TV and the memory pack and check the 9V battery inside the memory pack.

ABGLEICHVERFAHREN

Die Fernbedienung dient zum Eingeben und Abspeichern der Einstellwerte, mit Ausnahme der Sperrpunkteinstellung, die grundsätzlich vor den hier beschriebenen Einstellungen vorgenommen werden muss. Die Einstellung erfolgt entsprechend dem Bildschirm–Display. Auf dem Bildschirm–Display erscheinen auch die CCU–Varianten sowie die ungefähren Einstellwerte. Die Einstellfolge für den Service–Modus ist nachstehend beschrieben.

- Um in den Service–Mode zu gelangen, gehen sie bitte wie folgt vor:
 - Stellen sie im Toneinstellungs–Menü die Bässe auf Maximum und die Höhen auf Minimum.
 - Halten sie die REVEAL–Taste auf der Fernbedienung gedrückt und drücken zusätzlich die Taste –/v im Bedienteil des TV–Gerätes. Auf dem Bildschirm erscheint die entsprechende Anzeige für den Service–Mode.
- Die einzelnen Funktionen mit Hilfe der ROTEN und GRÜNEN Taste anwählen.
- Mit der GELBEN und BLAUEN Taste die Werte der einzelnen Funktionen ändern.
- Nach jeder Einstellung die Taste STR auf der Fernbedienung oder am Bedienfeld drücken, um die geänderten Werte abzuspeichern.
- Zum Verlassen des Service–Modus die "N"–Taste auf der Fernbedienung drücken

HINWEIS: Dieses FS–Gerät bietet auch die Möglichkeit eines Memory Pack, mit dem Sie die gewählten Fernsehkanäle abspeichern und auf jedes beliebige EURO2M FS–Gerät umkopieren können.

Kopieren der Einstelldaten vom FS–Gerät in das Memory Pack

- Das Memory Pack in die AV2–Buchse an der Rückseite des FS–Gerätes stecken und das Gerät einschalten.
- Wie schon oben beschrieben auf Service–Modus umschalten. Auf dem Bildschirm erscheint:

Program
External>>TV

- Nun die blaue Taste an der Fernbedienung betätigen. Auf dem Bildschirm erscheint:

Program
TV>>External

- Die Taste STORE am Fernseher drücken. Der Bildschirm meldet nun:

Storing

- Die im FS–Gerät abgespeicherten Kanal–Einstelldaten werden nun in das Memory Pack überspielt. bei abgeschlossener Datenübertragung meldet der Bildschirm:

OK!

Kopieren der Einstelldaten vom Memory Pack in das FS–Gerät

- Das Memory Pack in die AV2–Buchse an der Rückseite des FS–Gerätes stecken und das Gerät einschalten.
- Wie schon oben beschrieben auf Service–Modus umschalten. Auf dem Bildschirm erscheint:

Program
External>>TV

- Die Taste STORE am Fernseher drücken. Der Bildschirm meldet nun:

Loading

- Die im Memory Pack abgespeicherten Einstelldaten werden nun in das FS–Gerät überspielt. bei abgeschlossener Datenübertragung meldet der Bildschirm:

OK!

- Die Kanal–Einstelldaten sind damit vom Memory Pack in das FS–Gerät überspielt.
- Zum Verlassen des Service–Modus die "N"–Taste auf der Fernbedienung drücken
- Der Kopiervorgang ist somit abgeschlossen, und das Memory Pack kann von der Steckerleiste abgezogen werden.

Fehler

Falls beim Gebrauch des Memory Packs Fehler auftreten, zeigt das FS–Gerät dies auf dem Bildschirm mit der folgenden Meldung an:

Program
Error!

In diesem Fall muss der Service–Modus durch Drücken der "N"–Taste auf der Fernbedienung verlassen und anschliessend der Vorgang wiederholt werden. Falls weiterhin Fehlermeldungen erscheinen, müssen die Anschlusskontakte zwischen FS–Gerät und Memory Pack sowie die 9V Batterie im Memory Pack kontrolliert werden.

ADJUSTMENT PROCEDURE

Item/Preparation	Adjustments
+B SET-UP 1. Receive a test pattern 2. Set the controls: Brightness minimum Contrast minimum Volume minimum	1. Set the +B voltage up as follows: Adjust R811 so that B2 shows 147V{TX-21MD3F 130V} $\pm 1V$ 2. Confirm the following voltages. B1 200 \pm 10V B6 12 \pm 0.5V B3 27 \pm 1V B7 5 +0.1/-0.25V B4 35.5 \pm 1V B8 5 \pm 0.25V B5 15.5 \pm 1V U33 31 \pm 1V
RF AGC 1. Receive a test pattern. 2. Connect an oscilloscope between the tuner RF AGC and ground. 3. Set the oscilloscope gain range to 1V/div.	1. Check that the noise becomes large when the RF AGC VR R126 is turned counterclockwise. After the check turn it clockwise. 2. Gradually turn the RF AGC VR anti-clockwise, and set the RF AGC VR to the point where the RF AGC voltage is just falling to a point where this voltage drops by 0.2V from the maximum value.
CUT OFF 1. Receive a test pattern. 2. Degauss the tube externally. 3. Set the TV into Service Mode 1. 4. Select Cutoff DC mode.	1. Confirm then value is 128 and select Ug2 mode noting colour with largest value. 2. Turn the screen VR until a colour reaches 20~ 30. 3. Connect an oscilloscope to the cathode with the biggest value colour. 4. Select Cutoff DC mode and adjust Cutoff pulse to 159V \pm 5V. 5. Disconnect the oscilloscope and adjust the screen to whichever colour reaches 70 \pm 30 first.

ABGLEICH

Vorbereitung	Abgleich
+B - Abgleich 1. Testbild empfangen. 2. Helligkeit auf Minimum Kontrast auf Minimum Lautstärke auf Minimum	1. Mit R811 muß die B2 auf 147V (TX-21MD3F 130V) $\pm 1V$ eingestellt werden. 2. Folgende Spannungen sind zu überprüfen : B1 200 \pm 10V B6 12 \pm 0.5V B3 27 \pm 1V B7 5 +0.1/-0.25V B4 35.5 \pm 1V B8 5 \pm 0.25V B5 15.5 \pm 1V U33 31 \pm 1V
RF AGC 1. Testbild empfangen. 2. An die Tuner RF AGC und Masse ein Oszilloskop anschließen. 3. Die Empfindlichkeit des Oszilloskopes auf 1V/div. einstellen.	1. Wenn das Poti R126 (RF AGC) gegen den Uhrzeigersinn gedreht wird. muß das Rauschen zunehmen. 2. Das Poti R126 gegen den Uhrzeigersinn so einstellen, daß die eingestellte Spannung um 0,2V unter dem Maximalwert.
CUT OFF 1. Testbild empfangen. 2. Bildröhre entmagnetisieren. 3. Service-Mode 1 anwählen. 4. Im Service-Mode den Abgleichpunkt Cutoff DC-Mode wählen (14).	1. Im Feld Cutoff DC muß der Wert 128 stehen, Im Ugz-Feld muß Farbe mit dem höchstem Wert notiert werden. 2. Mit dem Screen-Poti wird die Farbe auf 20 bis 30 eingestellt. 3. An die Kathode mit den höchsten Wert (aus Punkt 1) wird ein Oszilloskop angeschlossen. 4. Im Cutoff DC Mode wird der Cutoff-Puls auf 159V \pm 5V eingestellt. 5. Das Oszilloskop entfernen und im Cutoff Mode die Werte so einstellen, daßsie alle bis 70 \pm 30 liegen.

SELF CHECK

Self check is used to automatically check the Bus lines and Hexadecimal code of the TV set.

To enter the Self Check mode press Function down button, on the Preset Panel, at the same time pressing the Status button, on the Remote Control, and the screen will show: –

When exiting Self Check the customer settings will return to factory setup.

1	— ok	Tuner	11	— --	Dolby IC for C/R	21	— ok	P SBLED
2	— ok	VIF	12	— ok	P S MODE	22	— ok	P OFF
3	— ok	EEPROM	13	— ok	P TA0	23	— ok	P DEFL
4	— --	Sound AV switch1	14	— ok	P TA1	24	— ok	P RAM
5	— ok	Video AV switch1	15	— ok	P TA2			
6	— ok	VDP	16	— ok	P TA3	Hex codes		
7	— ok	TPU	17	— ok	P SDA	6A		
8	— ok	MSP	18	— ok	P SCL1	22		
9	— --	Dolby Sub	19	— ok	P SCL3	21		
10	— --	Dolby IC for L/R	20	— ok	P SCL4	94		
						95		

If the CCU ports have been checked and found to be incorrect then "—" will appear in place of "OK".

SELBSTDIAGNOSE

1) Die Selbstdiagnose dient zum automatischen Prüfen der Bus-Leitungen sowie des Hexadezimalcodes des FS-Geräts. Zum Umschalten auf Selbstdiagnose nach dem Drücken der "F"-Taste die "Lautstärke Minus" Taste am Bedienfeld des FS-Geräts und gleichzeitig die Taste "Status" an der Fernbedienung drücken; auf dem Bildschirm erscheint hierauf: –

2) Nach der Selbstdiagnose wird das Gerät automatisch auf sämtliche werksseitigen Standardeinstellungen zurückgesetzt: –

1	— ok	Tuner	11	— --	Dolby IC for C/R	21	— ok	P SBLED
2	— ok	ZF-Verstärker	12	— ok	P S MODE	22	— ok	P OFF
3	— ok	EEPROM	13	— ok	P TA0	23	— ok	P DEFL
4	— --	Audio AV-Schalter 1	14	— ok	P TA1	24	— ok	P RAM
5	— ok	Video AV switch1	15	— ok	P TA2			
6	— ok	Video AV-Schalter 1	16	— ok	P TA3	Hex codes		
7	— ok	Video AV-Schalter 2	17	— ok	P SDA	6A		
8	— ok	MSP	18	— ok	P SCL1	22		
9	— --	Dolby Sub	19	— ok	P SCL3	21		
10	— --	Dolby IC for L/R	20	— ok	P SCL4	94		
						95		

Wenn der Hauptprozessor (CCU) an den Anschlüssen einen Fehler finden sollte, oder der Anschluss nicht belegt ist, zeigt die entsprechende Position -- anstelle von OK an.

ALIGNMENT SETTINGS

(The figures used below are nominal and used for representative purposes only)

Alignment Function		Settings / Special features
1. Vertical amplitude	V-AMP 051	Optimum setting
2. Vertical symmetry	V-SYM 013	
3. Vertical linearity	V-LIN 012	
4. Vert. D.C.	Vert. D.C. 000	No adjustment
5. V-Pos.	V. Pos. 003	Optimum setting
6. Horizontal amplitude	H-AMP -033	Optimum setting
7. Horizontal position	H-POS 049	
8. Text Position	TEXT POSITION 045	Optimum setting
9. EW-amplitude	E-W-AMP 1 -058	Optimum setting
10. EW-amplitude	E-W-AMP 2 023	Optimum setting
11. Trapezium-comp	TRAPEZ-1 -014	Optimum setting
12. Trapezium- comp	TRAPEZ-2 012	Optimum setting
13. Colour VCO	Colour VCO 015	Optimum setting
14. Cut-off DC	Cut-off DC 050	No adjustment
15. Ug2 Test	Ug 2 Test 107 021 023	Select Cutoff DC in ServiceMode and confirm the value is 128. Select Ug 2 Test noting colour with largest value, adjust on FBT until a colour reaches 20 ~ 30. Connect an oscilloscope to the cathode of the biggest value colour, select Cutoff DC mode and adjust get Cutoff pulse voltage to 159±5V. Disconnect the oscilloscope and adjust the screen to whichever colour reaches 70±30 first.
16. Cutoff	Cutoff 045 055 050	Press the GREEN button to step through the settings. Adjust for optimum.
17. White	White 224 255 237	Press the GREEN button to step through the settings. Adjust for optimum.

ABGLEICHTABELLE

(Die angegebenen Werte sind Mittelwerte und Können individuell nach oben oder unten nach dem korrekten Abgleich abweichen)

Abgleichfunktion		Einstellung/Besondere Merkmale
1. Vertikale Amplitude	V-AMP 054	Optimale Einstellung.
2. Vertikale symmetrie	V-SYM 002	
3. Vertical linearität	V-LIN 006	
4. Vert. DC	Vert. D.C. 000	Nicht einstellen.
5. V-Pos	V. Pos. 005	Optimale Einstellung.
6. Horizontale Amplitude	H-AMP 055	Optimale Einstellung.
7. Horizontale position	H-POS 061	
8. Text Position	TEXT POSITION 048	Optimale Einstellung.
9. OW-amplitude	E-W-AMP 1 -128	Optimale Einstellung.
10. OW-amplitude	E-W-AMP 2 006	Optimale Einstellung.
11 Trapez-Kompensation	TRAPEZ-1 047	Optimale Einstellung.
12. Trapez-Kompensation	TRAPEZ-2 -128	Optimale Einstellung.
13. Colour VCO	Colour VCO -005	Optimale Einstellung.
14. Cut-off DC	Cut-off DC 171	Nicht einstellen.
15. Bildschirm	Ug 2 Test 006 055 059	Wählen Sie den Cutoff DC Im Service Mode und bestätigen Sie den Wert 128. Im Ug2-Feld muß die Farbe mit dem höchsten Wert notiert werden. Mit dem Screen-Poti wird die Farbe auf 20 bis 30 eingestellt. An die Kathode mit den höchsten Wert (aus Punkt 1) wird ein Oszilloskop angeschlossen. Im Cutoff DC Mode wird der Cutoff-Puls auf $159V \pm 5V$ eingestellt. Das Oszilloskop entfernen und im Cutoff Mode die Werte so einstellen, daß sie alle bis 70 ± 30 liegen.
16. Cutoff	Cutoff 034 052 056	Die Einstellungen mit Hilfe der GRÜNEN Taste anwählen. Optimale Einstellung.
17. White	White 216 255 216	Die Einstellungen mit Hilfe der GRÜNEN Taste anwählen. Optimale Einstellung.

WAVEFORM PATTERN TABLE

SIGNAL TABELLE

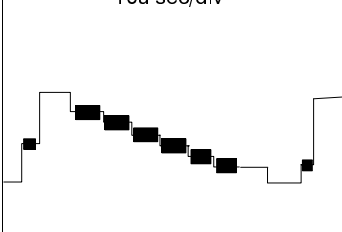
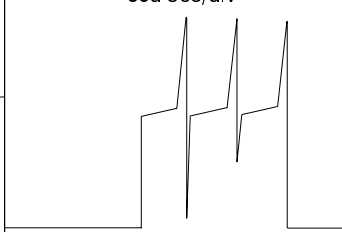
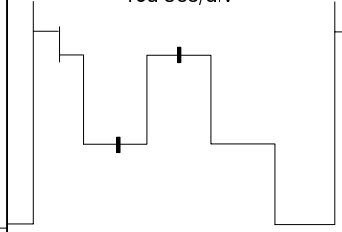
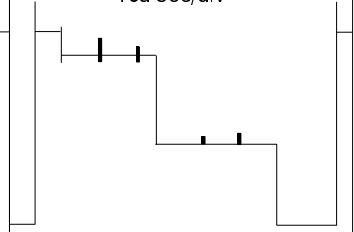
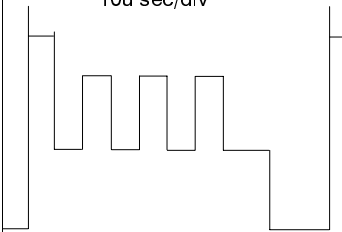
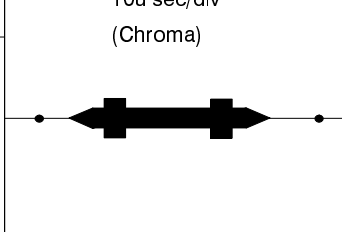
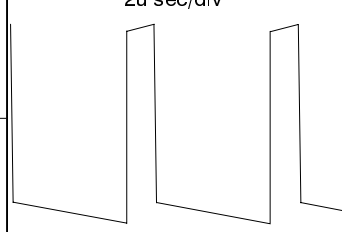
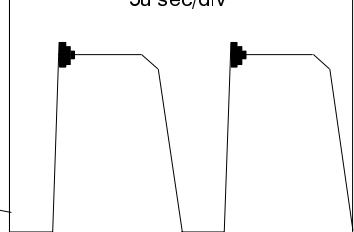
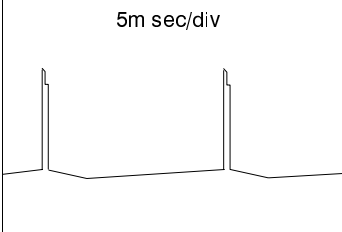
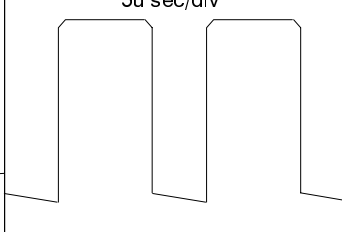
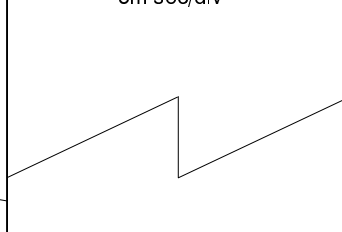
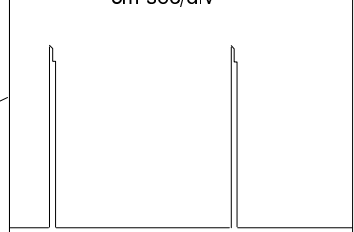
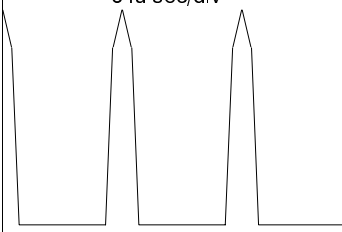
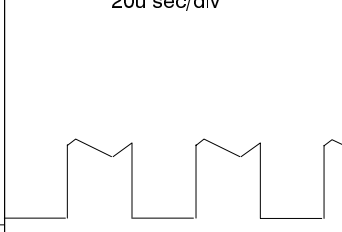
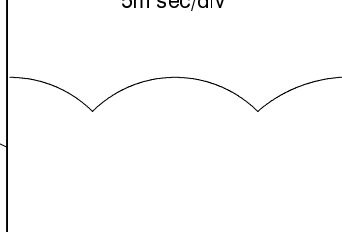
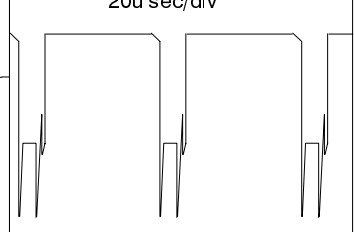
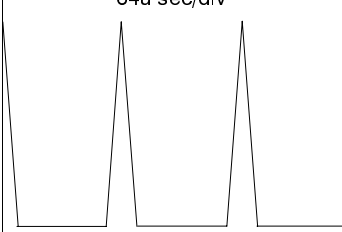
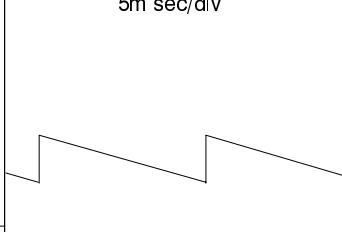
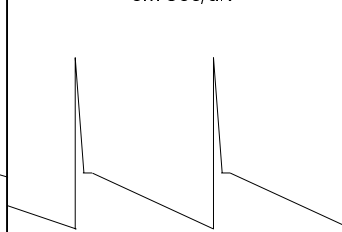
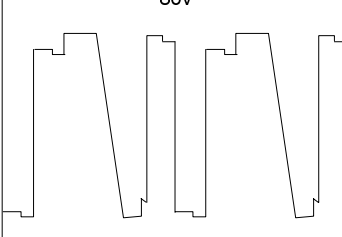
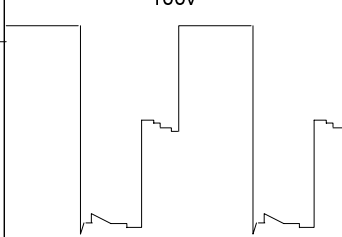
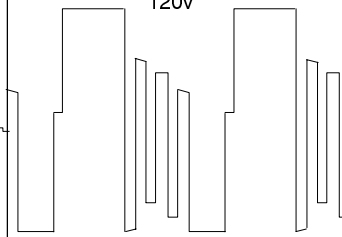
<p>PIN 42 I601 10u sec/div</p> 	<p>PIN 6 E8 50u sec/div</p> 	<p>PIN 5 E8 10u sec/div</p> 	<p>PIN 3 E8 10u sec/div</p> 
<p>PIN 4 E8 10u sec/div</p> 	<p>PIN 44 IC601 10u sec/div (Chroma)</p> 	<p>PIN 7 IC801 2u sec/div</p> 	<p>PIN 18 T801 5u sec/div</p> 
<p>PIN 6 IC451 5m sec/div</p> 	<p>PIN 3 IC801 5u sec/div</p> 	<p>PIN 6 IC601 5m sec/div</p> 	<p>PIN 34 IC601 5m sec/div</p> 
<p>COLLECTOR Q551 64u sec/div</p> 	<p>BASE Q503 20u sec/div</p> 	<p>PIN 7 IC701 5m sec/div</p> 	<p>BASE Q551 20u sec/div</p> 
<p>PIN 8 IC701 64u sec/div</p> 	<p>PIN 1 IC451 5m sec/div</p> 	<p>PIN 5 IC451 5m sec/div</p> 	
<p>RED DRIVE EMITTER Q351 80v</p> 	<p>GREEN DRIVE EMITTER Q352 100v</p> 	<p>BLUE DRIVE EMITTER Q353 120v</p> 	

VIDEO BLOCK DIAGRAM BILD SIGNAL BLOCKSCHEMA

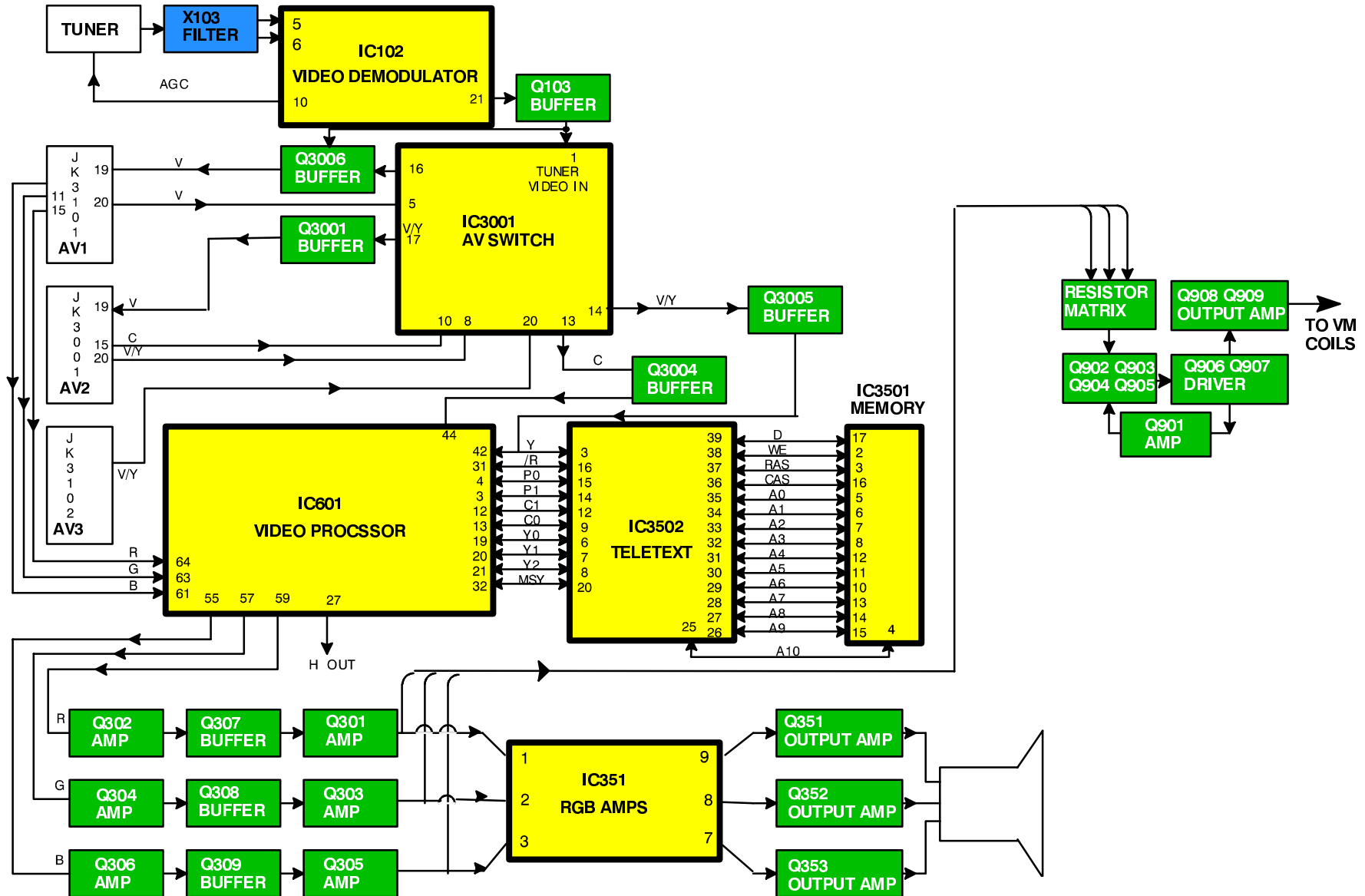

AUDIO BLOCK DIAGRAM

TONSIGNAL BLOCKSCHEMA

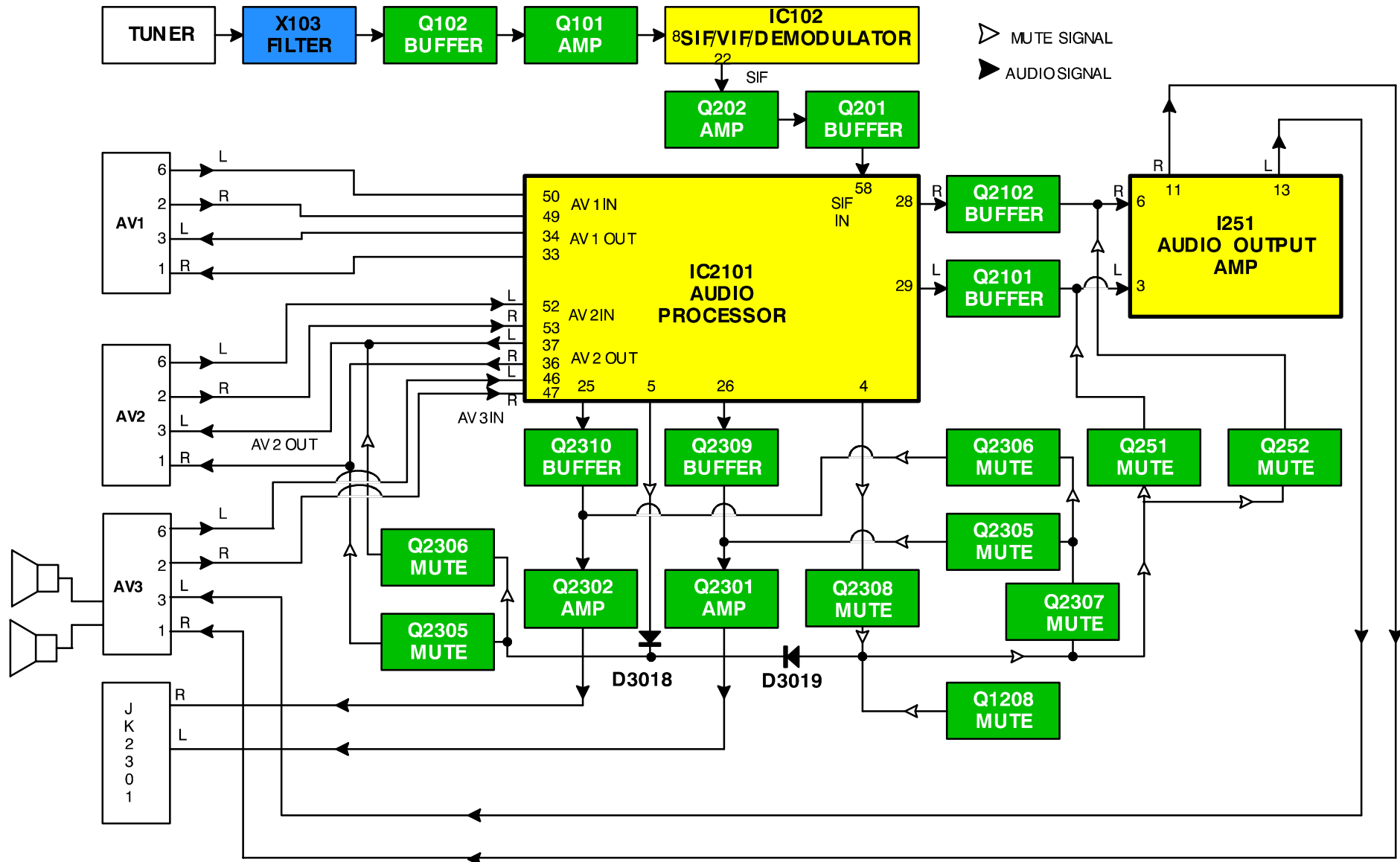

POWER SUPPLY AND CONTROL BLOCK DIAGRAM STROMVERSORGUNGS BLOCKSCHEMA

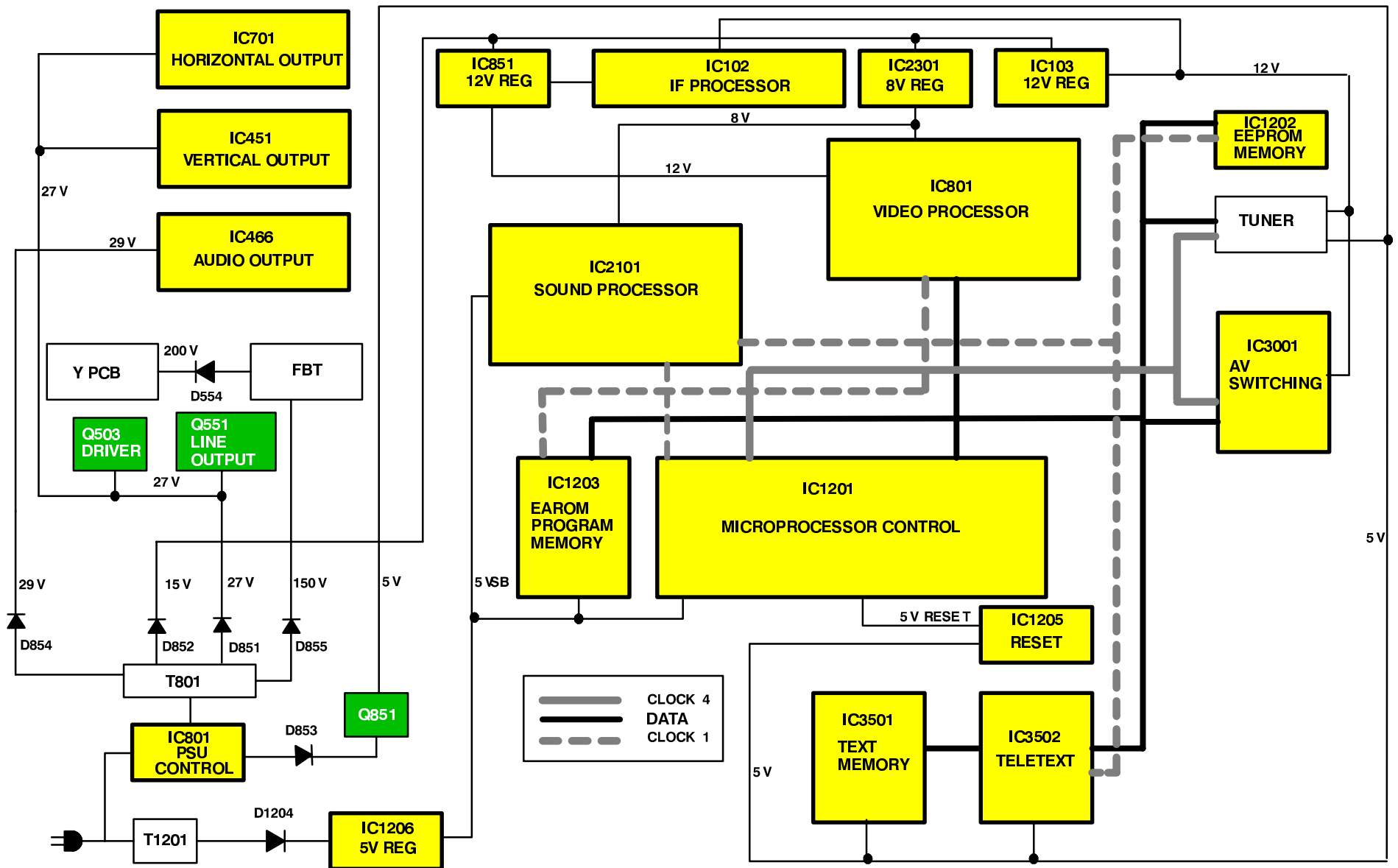

PARTS LOCATION

NOTE :

The numbers on the exploded view below refer to the miscellaneous section of the Replacement Parts List.

EXPLOSIONSZEICHNUNG

Anmerking :

Die Nummer auf den mechanischen Teilen zeigt die Bezugsnummer der Ersatzteilliste an.

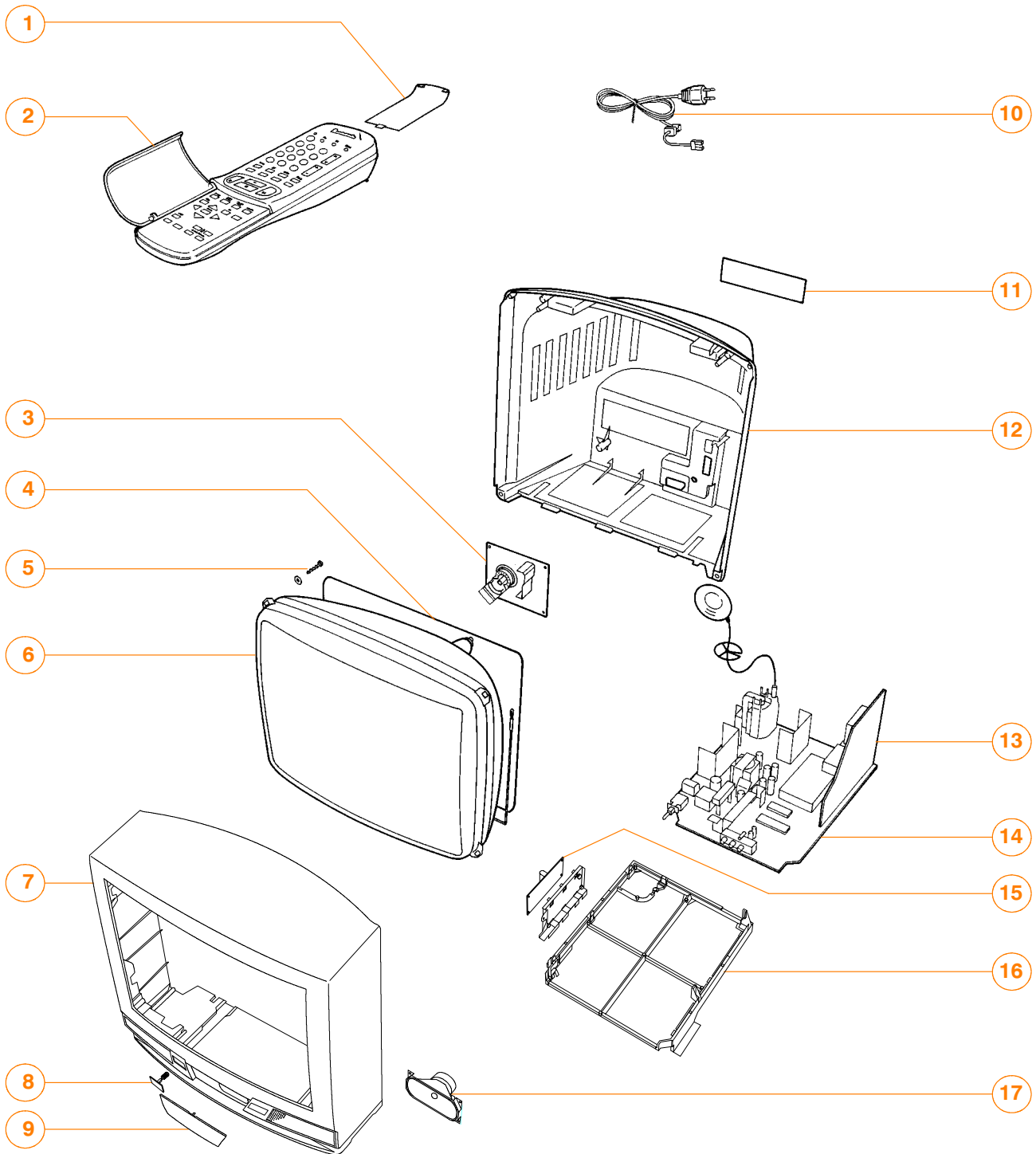

REPLACEMENT PARTS LIST

Important Safety Notice

Components identified by ▲ mark have special characteristics important for safety. When replacing any of these components, use only manufacturer's specified parts.

COMMON PARTS FOR MODELS TX-28MD3F, TX-25MD3F AND TX-21MD3F

Ref No.	Part No.	Description	
MISCELLANEOUS COMPONENTS			
1)	UR51EC780	BATTERY COVER (REMOTE)	
2)	EUR51920	REMOTE CONTROL	
3)	*****	REFER TO DIFFERENCE LIST	
4)	*****	REFER TO DIFFERENCE LIST	
5)	*****	REFER TO DIFFERENCE LIST	
6)	*****	REFER TO DIFFERENCE LIST	
7)	*****	REFER TO DIFFERENCE LIST	
8)	*****	REFER TO DIFFERENCE LIST	
9)	TKP8E1177	DOOR LID	
10)	TSX8E0020	POWER CORD	▲
11)	*****	REFER TO DIFFERENCE LIST	
12)	*****	REFER TO DIFFERENCE LIST	
13)	TNP8EB007AB	B PCB	▲
14)	*****	REFER TO DIFFERENCE LIST	
15)	TNP8EP013AB	P .PC.B.	▲
16)	TMX8E010	CHASSIS BRACKET	
17)	EASG12D531F2	SPEAKER	
	F9-4-220	RELAY	
	TBM8E1619-1	PRESET LABEL	
	TBM8E1622	MODEL LABEL	
	TEK6935	LID SWITCH	
	ENG29501G	TUNER	
	TKP8E1178	LED PANEL	
	TKP8E1179	LED TUBE	
	TMW8E020	LED HOLDER	
	TQB8E2279A	GERMAN INST BOOK	▲
	TQB8E2279C	ITALIAN INST BOOK	▲
	TQB8E2279D	FRENCH INST BOOK	▲
	TQB8E2279E	SPANISH INST BOOK	▲
	UM-3DEP-2P	BATTERY	
	31221212478	FIX CLIP	
	TES4537	SPRING	
INTEGRATED CIRCUITS			
IC100	TSA5514AT/C2	A.F.C.CONTROL	
IC103	L78M09MRB	9V REGULATOR	
IC251	LA4280-TV	AUDIO OUTPUT	
IC351	TDA6103Q-N3	R.G.B.AMPLIFIER	
IC451	LA7845N	VERTICAL OUTPUT	
IC601	VDP3108APPA1	VIDEO PROCESSOR	
IC701	TEA2031A	HORIZONTAL OUTPUT	
IC801	TDA4601	POWER SUPPLY	
IC851	L78M12MRB	12V REGULATOR	
IC1051	RPM-637CBRL	LED RECEIVER	
IC1201	CCU30001-07	CENTRAL CONTROL UNIT	
IC1205	MN1280R	RESET	
IC2101	MSP3410BPPF7	AUDIO PROCESSOR	
IC2301	AN78L08TA	8V REGULATOR	
IC3001	TEA6415C	VIDEO SWITCH	
IC3501	UD61256DC-08	DYNAMIC RAM	
IC3502	TPU3040-20	TEXT PROCESSOR	

ERSATZTEILLISTE

Wichtiger Sicherheitshinweis

Teile, die mit einem Hinweis ▲ gekennzeichnet sind, sind wichtig für die Sicherheit. Sollte ein Auswechsein erforderlich sein, sind unbedingt Originalteile einzusetzen.

Ref No.	Part No.	Description	
CAPACITORS			
C100	ECUV1H104ZFX	S.M.CAP	50V 100nF
C101	ECUV1H104ZFX	S.M.CAP	50V 100nF
C102	ECUV1H104ZFX	S.M.CAP	50V 100nF
C103	ECUV1H104ZFX	S.M.CAP	50V 100nF
C104	ECUV1H104ZFX	S.M.CAP	50V 100nF
C107	ECUV1H104ZFX	S.M.CAP	50V 100nF
C124	ECEA1CKA470	ELECT	16V 47µF
C130	ECEA1CKA470	ELECT	16V 47µF
C135	ECUV1H103ZFX	S.M.CAP	50V 10nF
C136	ECA1CM100GB	ELECT	16V 10pF
C137	ECA1EM101GB	ELECT	25V 1µF
C138	ECUV1H103ZFX	S.M.CAP	50V 10nF
C139	ECUV1H390JCX	S.M.CAP	50V 39pF
C140	ECUV1H390JCX	S.M.CAP	50V 39pF
C141	ECUV1H103ZFX	S.M.CAP	50V 10nF
C144	ECA1HMR33GB	ELECT	50V 0.33µF
C145	ECUV1H103ZFX	S.M.CAP	50V 10nF
C146	ECUV1H104ZFX	S.M.CAP	50V 100nF
C147	ECUV1H102KBX	S.M.CAP	50V 1nF
C148	ECEA1HKAR22	ELECT	50V 0.22µF
C149	ECA1EM470GB	ELECT	25V 47pF
C150	ECUV1H103ZFX	S.M.CAP	50V 10nF
C151	ECUV1H104ZFX	S.M.CAP	50V 100nF
C154	ECA1CM221GB	ELECT	16V 220pF
C170	ECUV1H331KBX	S.M.CAP	50V 330pF
C201	ECUV1H070DCX	S.M.CAP	50V 7pF
C202	ECUV1H070DCX	S.M.CAP	50V 7pF
C203	ECUV1H470JX	S.M.CAP	50V 47pF
C204	ECUV1H560JCX	S.M.CAP	50V 56pF
C205	ECUV1H560JCX	S.M.CAP	50V 56pF
C207	ECUV1H560JCX	S.M.CAP	50V 56pF
C209	ECUV1H104ZFX	S.M.CAP	50V 100nF
C210	ECUV1H103ZFX	S.M.CAP	50V 10nF
C211	ECUV1H104ZFX	S.M.CAP	50V 100nF
C253	ECA1HM4R7GB	ELECT	50V 4.7µF
C255	ECEA1EGE101	ELECT	25V 100µF
C257	ECA1HM4R7GB	ELECT	50V 4.7µF
C260	ECA1VM102GE	ELECT	35V 1nF
C261	ECA1VM102GE	ELECT	35V 1nF
C263	ECA1HM010GB	ELECT	50V 1pF
C264	ECEA1HGE222	ELECT	50V 2200µF
C266	ECA1HM010GB	ELECT	50V 1pF
C267	ECUV1H104KBX	S.M.CAP	50V 100nF
C268	ECUV1H104KBX	S.M.CAP	50V 100nF
C271	ECUV1H561KBX	S.M.CAP	50V 560pF
C301	ECA1CM470GB	ELECT	16V 47µF
C302	ECUV1H104ZFX	S.M.CAP	50V 100nF
C303	ECUV1H104ZFX	S.M.CAP	50V 100nF
C310	ECUV1H104ZFX	S.M.CAP	50V 100nF
C354	ECQM2104KZ	FILM	250V 100nF
C355	ECUV1H222JCX	S.M.CAP	50V 2.2nF
C356	ECUV1H222JCX	S.M.CAP	50V 2.2nF
C357	ECUV1H222JCX	S.M.CAP	50V 2.2nF
C358	222236516224	FILM	160V 220nF
C360	ECKC3D152J	CERAMIC	2KV 1.5nF ▲
C361	ECA1HMR47GB	ELECT	50V 0.47µF
C451	ECUV1H102JX	S.M.CAP	50V 1nF
C452	ECUV1H102ZFX	S.M.CAP	50V 1nF
C453	ECUV1H472KBX	S.M.CAP	50V 4.7nF
C454	ECUV1H104ZFX	S.M.CAP	50V 100nF

Ref No.	Part No.	Description			
C456	ECEA1HGE221	ELECT	50V	220µF	
C458	ECQM1H273J	FILM	50V	27nF	
C460	222236516105	FILM	160V	1µF	
C462	ECEA1VGE332	ELECT	35V	3300µF	
C501	ECA1AM330GB	ELECT	10V	33pF	
C506	ECUV1H103ZFX	S.M.CAP	50V	10nF	
C508	222236516105	FILM	160V	1µF	
C509	ECEA1HGE101	ELECT	50V	100µF	
C510	ECUV1H104ZFX	S.M.CAP	50V	100nF	
C511	ECQM2683JZ	FILM	250V	68nF	
C555	ECWH12H103J	FILM	1250V	10nF	△
C562	ECKC2H101J	CERAMIC	500V	100pF	△
C563	ECEA2EU220	ELECT	250V	22µF	
C564	ECEA2AU2R2	ELECT	100V	2.2µF	
C565	ECQP1H273J	FILM	100V	2700µF	
C601	ECUV1H271JCX	S.M.CAP	50V	270pF	
C602	ECUV1H121JCX	S.M.CAP	50V	120pF	
C603	ECUV1H471JCX	S.M.CAP	50V	470pF	
C604	ECA0JM102GB	ELECT	6.3V	1nF	
C605	ECUV1H103ZFX	S.M.CAP	50V	10nF	
C608	ECUV1H683ZFX	S.M.CAP	50V	68nF	
C609	ECA1CM470GB	ELECT	16V	47µF	
C610	ECUV1H683ZFX	S.M.CAP	50V	68nF	
C611	ECUV1H104ZFX	S.M.CAP	50V	100nF	
C612	ECUV1H103ZFX	S.M.CAP	50V	10nF	
C613	ECUV1H102JCX	S.M.CAP	50V	1nF	
C614	ECUV1H104ZFX	S.M.CAP	50V	100nF	
C615	ECUV1H103ZFX	S.M.CAP	50V	10nF	
C616	ECUV1H103ZFX	S.M.CAP	50V	10nF	
C618	ECUV1H473ZFX	S.M.CAP	50V	47nF	
C619	ECUV1H104ZFX	S.M.CAP	50V	100nF	
C620	ECUV1H104ZFX	S.M.CAP	50V	100nF	
C621	ECA1CM100GB	ELECT	16V	10pF	
C622	ECA1CM100GB	ELECT	16V	10pF	
C623	ECUV1H104ZFX	S.M.CAP	50V	100nF	
C624	ECUV1H103ZFX	S.M.CAP	50V	10nF	
C626	ECA0JM102GB	ELECT	6.3V	1nF	
C627	ECUV1H100DCX	S.M.CAP	50V	10pF	
C628	ECUV1H470JCX	S.M.CAP	50V	47pF	
C629	ECUV1H101JCX	S.M.CAP	50V	100pF	
C630	ECUV1H104ZFX	S.M.CAP	50V	100nF	
C631	ECUV1H104ZFX	S.M.CAP	50V	100nF	
C632	ECUV1H104ZFX	S.M.CAP	50V	100nF	
C633	ECUV1H102JCX	S.M.CAP	50V	1nF	
C636	ECUV1H101JCX	S.M.CAP	50V	100pF	
C637	ECUV1H102KBX	S.M.CAP	50V	1nF	
C638	ECUV1H181JCX	S.M.CAP	50V	180pF	
C639	ECUV1H561KBX	S.M.CAP	50V	560pF	
C702	ECUV1H103KBX	S.M.CAP	50V	10nF	
C704	ECQB1H223K	FILM	50V	22nF	
C705	ECQB1H152K	FILM	50V	1.5nF	
C801	ECUV1H101JCX	S.M.CAP	50V	100pF	
C802	ECQE6104K	FILM	600V	100nF	△
C803	ECUV1H560JX	S.M.CAP	50V	56pF	
C804	ECA1HM101GB	ELECT	50V	100pF	
C805	ECUV1H104ZFX	S.M.CAP	50V	100nF	
C806	ECEA1HU101	ELECT	50V	100µF	
C807	ECEA1EGE101	ELECT	25V	100µF	
C808	ECQB1H103J	FILM	50V	10nF	
C809	ECQB1H103J	FILM	50V	10nF	
C811	ECEA1HN010	ELECT	50V	1µF	
C815	ECKC2H472J	CERAMIC	500V	4.7nF	△
C816	ECKC3D222JB	CERAMIC	2KV	2200pF	△
C817	ECQB1H223K	FILM	50V	22nF	
C818	ECKC2H472J	CERAMIC	500V	4.7nF	△
C821	ECKWNA332MECCERAMIC		250V	3.3nF	
C841	222233510224	CAPACITOR		0.22µF	
C851	ECKC2H681J	CERAMIC	500V	680pF	△
C852	ECEA1HU102	ELECT	50V	1000µF	
C853	ECEA1EGE222	ELECT	25V	2200µF	
C854	ECEA1HGE102	ELECT	50V	1000µF	

Ref No.	Part No.	Description			
C855	ECKC3D471JB	CERAMIC	2KV	470pF	△
C856	ECEA1EGE222	ELECT	25V	2200µF	
C858	ECUV1H103ZFX	S.M.CAP	50V	10nF	
C859	ECUV1H103ZFX	S.M.CAP	50V	10nF	
C860	ECA1CM471GB	ELECT	16V	470pF	
C862	ECA1CM471GB	ELECT	16V	470pF	
C1051	ECA0JM101G	ELECT	6.3V	100pF	
C1052	ECUV1H104ZFX	S.M.CAP	50V	100nF	
C1201	ECUV1H332KBX	S.M.CAP	50V	3.3nF	
C1202	ECUV1H332KBX	S.M.CAP	50V	3.3nF	
C1203	ECUV1H332KBX	S.M.CAP	50V	3.3nF	
C1204	ECUV1H332KBX	S.M.CAP	50V	3.3nF	
C1205	ECUV1H103ZFX	S.M.CAP	50V	10nF	
C1206	ECA1HM4R7GB	ELECT	50V	4.7µF	
C1207	ECUV1H472KBX	S.M.CAP	50V	4.7nF	
C1208	ECUV1H390JCX	S.M.CAP	50V	39pF	
C1209	ECUV1H390JCX	S.M.CAP	50V	39pF	
C1210	ECUV1H103ZFX	S.M.CAP	50V	10nF	
C1211	ECUV1H470JCX	S.M.CAP	50V	47pF	
C1212	ECA1CM470GB	ELECT	16V	47µF	
C1213	ECUV1H103ZFX	S.M.CAP	50V	10nF	
C1214	ECA1CM470GB	ELECT	16V	47µF	
C1215	ECUV1H103ZFX	S.M.CAP	50V	10nF	
C1217	ECUV1H104ZFX	S.M.CAP	50V	100nF	
C1219	ECA1CM471GB	ELECT	16V	470pF	
C1220	ECUV1H103ZFX	S.M.CAP	50V	10nF	
C1221	ECA0JM102GB	ELECT	6.3V	1nF	
C1222	ECUV1H104ZFX	S.M.CAP	50V	100nF	
C1223	ECA1HM101GB	ELECT	50V	100pF	
C1224	ECA0JM222GB	ELECT	6.3V	2.2nF	
C1225	ECA0JM472GE	ELECT	6.3V	4.7nF	
C1226	ECA1HM101GB	ELECT	50V	100pF	
C1227	ECA1VM221B	ELECT	35V	220pF	
C1228	ECA1EM101GB	ELECT	25V	1µF	
C2101	ECUV1H223KBX	S.M.CAP	50V	22nF	
C2102	ECUV1H391KBX	S.M.CAP	50V	390pF	
C2103	ECUV1H102KBX	S.M.CAP	50V	1nF	
C2104	ECUV1H102KBX	S.M.CAP	50V	1nF	
C2107	ECUV1H391KBX	S.M.CAP	50V	390pF	
C2108	ECA1HM101GB	ELECT	50V	100pF	
C2109	ECUV1H223KBX	S.M.CAP	50V	22nF	
C2110	ECA1CM100GB	ELECT	16V	10pF	
C2111	ECUV1H104ZFX	S.M.CAP	50V	100nF	
C2112	ECA1CM100GB	ELECT	16V	10pF	
C2113	ECUV1H102KBX	S.M.CAP	50V	1nF	
C2114	ECUV1H104ZFX	S.M.CAP	50V	100nF	
C2115	ECUV1H471KBX	S.M.CAP	50V	470pF	
C2116	ECA1HM3R3GB	ELECT	50V	3.3µF	
C2117	ECUV1H471KBX	S.M.CAP	50V	470pF	
C2118	ECUV1H104ZFX	S.M.CAP	50V	100nF	
C2119	ECA1CM100GB	ELECT	16V	10pF	
C2120	ECUV1H104ZFX	S.M.CAP	50V	100nF	
C2121	ECUV1H104ZFX	S.M.CAP	50V	100nF	
C2123	ECA1CM100GB	ELECT	16V	10pF	
C2124	ECUV1H104ZFX	S.M.CAP	50V	100nF	
C2125	ECUV1H010CCX	S.M.CAP	50V	1pF	
C2126	ECUV1H010CCX	S.M.CAP	50V	1pF	
C2127	ECA1CM100GB	ELECT	16V	10pF	
C2128	ECUV1H683ZFX	S.M.CAP	50V	68nF	
C2129	ECQM1H334J	FILM	50V	330nF	
C2307	ECA1CM470GB	ELECT	16V	47µF	
C2308	ECA1CM470GB	ELECT	16V	47µF	
C2310	ECA1CM470GB	ELECT	16V	47µF	
C2312	ECUV1H104ZFX	S.M.CAP	50V	100nF	
C2313	ECUV1H103KBX	S.M.CAP	50V	10nF	
C2314	ECUV1H104ZFX	S.M.CAP	50V	100nF	
C2315	ECUV1H103KBX	S.M.CAP	50V	10nF	
C2316	ECUV1H103ZFX	S.M.CAP	50V	10nF	
C2317	ECA1CM470GB	ELECT	16V	47µF	
C2318	ECUV1H222KBX	S.M.CAP	50V	2.2nF	
C2319	ECUV1H222KBX	S.M.CAP	50V	2.2nF	
C2651	ECUV1H103KBX	S.M.CAP	50V	10nF	

Ref No.	Part No.	Description
C2652	ECUV1H103KBX S.M.CAP	50V 10nF
C3001	ECA1HMR47GB ELECT	50V 0.47µF
C3002	ECA1HMR47GB ELECT	50V 0.47µF
C3003	ECA1EM4R7GB ELECT	25V 4.7µF
C3004	ECA1HM4R7GB ELECT	50V 4.7µF
C3005	ECA1HM4R7GB ELECT	50V 4.7µF
C3006	ECUV1H473ZFX S.M.CAP	50V 47nF
C3007	ECA1HM470GB ELECT	50V 47µF
C3011	ECUV1H473ZFX S.M.CAP	50V 47nF
C3012	ECA1CM470GB ELECT	16V 47µF
C3013	ECUV1H104ZFX S.M.CAP	50V 100nF
C3014	ECUV1H104ZFX S.M.CAP	50V 100nF
C3017	ECEA1CN470 ELECT	16V 47µF
C3018	ECUV1H102KBX S.M.CAP	50V 1nF
C3019	ECUV1H102KBX S.M.CAP	50V 1nF
C3020	ECCR1H120J CERAMIC	50V 12pF
C3021	ECUV1H102KBX S.M.CAP	50V 1nF
C3023	ECA1CM470GB ELECT	16V 47µF
C3024	ECUV1H473ZFX S.M.CAP	50V 47nF
C3025	ECUV1H102KBX S.M.CAP	50V 1nF
C3026	ECA1CM470GB ELECT	16V 47µF
C3027	ECA1CM470GB ELECT	16V 47µF
C3028	ECUV1H221JX S.M.CAP	50V 220pF
C3029	ECUV1H221JX S.M.CAP	50V 220pF
C3030	ECUV1H221JX S.M.CAP	50V 220pF
C3031	ECUV1H221JX S.M.CAP	50V 220pF
C3032	ECA1HMR47GB ELECT	50V 0.47µF
C3033	ECA1HMR47GB ELECT	50V 0.47µF
C3034	ECUV1H221JX S.M.CAP	50V 220pF
C3035	ECUV1H221JX S.M.CAP	50V 220pF
C3036	ECUV1H222KBX S.M.CAP	50V 2.2nF
C3037	ECUV1H561JCX S.M.CAP	50V 560pF
C3038	ECA1CM470GB ELECT	16V 47µF
C3039	ECA1CM470GB ELECT	16V 47µF
C3040	ECA1HMR47GB ELECT	50V 0.47µF
C3041	ECA1HMR47GB ELECT	50V 0.47µF
C3043	ECA1HM4R7GB ELECT	50V 4.7µF
C3045	ECUV1H104ZFX S.M.CAP	50V 100nF
C3049	ECUV1H222KBX S.M.CAP	50V 2.2nF
C3050	ECUV1H222KBX S.M.CAP	50V 2.2nF
C3051	ECUV1H222KBX S.M.CAP	50V 2.2nF
C3052	ECUV1H222KBX S.M.CAP	50V 2.2nF
C3053	ECUV1H222KBX S.M.CAP	50V 2.2nF
C3054	ECUV1H222KBX S.M.CAP	50V 2.2nF
C3055	ECUV1H222KBX S.M.CAP	50V 2.2nF
C3056	ECUV1H101JCX S.M.CAP	50V 100pF
C3062	ECUV1H104ZFX S.M.CAP	50V 100nF
C3071	ECUV1H104ZFX S.M.CAP	50V 100nF
C3151	ECUV1H561JCX S.M.CAP	50V 560pF
C3152	ECUV1H561JCX S.M.CAP	50V 560pF
C3501	ECUV1H104ZFX S.M.CAP	50V 100nF
C3502	ECA1HM101GB ELECT	50V 100pF
C3503	ECUV1H103ZFX S.M.CAP	50V 10nF
C3504	ECUV1H102JCX S.M.CAP	50V 1nF
C3505	ECUV1H104ZFX S.M.CAP	50V 100nF
C3506	ECA1CM470GB ELECT	16V 47µF
C3507	ECA1CM470GB ELECT	16V 47µF
C3508	ECUV1H473ZFX S.M.CAP	50V 47nF
C3509	ECUV1H103ZFX S.M.CAP	50V 10nF
C3510	ECA0JM102GB ELECT	6.3V 1nF
C3511	ECUV1H103ZFX S.M.CAP	50V 10nF

DIODES

D140	MA3020TX	DIODE
D141	MA3020TX	DIODE
D251	MA2180TP	DIODE
D253	RB721Q40T77	DIODE
D254	RB721Q40T77	DIODE
D310	MA165TA5	DIODE 1SS133T-77
D311	MA29TA5	DIODE
D312	MA29TA5	DIODE

Ref No.	Part No.	Description
D354	ERA22-04V1	DIODE
D355	ERA22-04V1	DIODE
D356	ERA22-04V1	DIODE
D357	MA165TA5	DIODE 1SS133T-77
D358	MA165TA5	DIODE 1SS133T-77
D359	MA165TA5	DIODE 1SS133T-77
D360	MA4150	DIODE
D451	MA165TA5	DIODE 1SS133T-77
D452	MA165TA5	DIODE 1SS133T-77
D454	ERA15-02V3	DIODE
D456	MA2160BLFS	DIODE
D470	MA4020	DIODE
D501	MA165TA5	DIODE 1SS133T-77
D502	EU02	DIODE
D551	ERD07-15L7	DIODE
D552	TVSRU2AM	DIODE
D554	AU02V0	DIODE
D556	MA166TA5	DIODE
D601	MA165TA5	DIODE 1SS133T-77
D602	MA165TA5	DIODE 1SS133T-77
D604	MA165TA5	DIODE 1SS133T-77
D605	MA165TA5	DIODE 1SS133T-77
D606	MA165TA5	DIODE 1SS133T-77
D609	MA167TA5	DIODE
D701	MA165TA5	DIODE 1SS133T-77
D702	MTZJT-775.6C	DIODE
D804	ERA15-02V3	DIODE
D805	EU02	DIODE
D806	RBV4-08	DIODE
D807	EU02	DIODE
D809	MA165TA5	DIODE 1SS133T-77
D814	MA165TA5	DIODE 1SS133T-77
D851	EU02	DIODE
D852	ERD32-02L7	DIODE
D853	FML22SLF610	DIODE
D854	RU4AMLF-M1	DIODE
D855	RU4BLF-L1	DIODE
D856	MTZJT-775.1A	DIODE
D857	MTZJ33B	DIODE
D858	MA29TA5	DIODE
D1201	SLR56UR3FLF	LED
D1203	MA170	DIODE
D1205	MA165TA5	DIODE 1SS133T-77
D1207	MA165TA5	DIODE 1SS133T-77
D1208	MA165TA5	DIODE 1SS133T-77
D1209	MA165TA5	DIODE 1SS133T-77
D1211	MTZJT-775.1C	DIODE
D1212	MA170	DIODE
D1213	MA165TA5	DIODE 1SS133T-77
D1214	MA170	DIODE
D1216	MTZJT-778.2C	DIODE
D2303	MA165TA5	DIODE 1SS133T-77
D2304	MTZJT-779.1C	DIODE
D3001	MTZJT-7712C	DIODE
D3003	MTZJT-778.2C	DIODE
D3004	MA4100	DIODE
D3005	MTZJT-7712C	DIODE
D3006	MTZJT-7712C	DIODE
D3007	MTZJT-7712C	DIODE
D3008	MTZJT-778.2C	DIODE
D3009	MTZJT-778.2C	DIODE
D3010	MTZJT-778.2C	DIODE
D3011	MTZJT-778.2C	DIODE
D3012	MTZJT-7712C	DIODE
D3013	MTZJT-7712C	DIODE
D3014	MTZJT-7712C	DIODE
D3015	MTZJT-7712C	DIODE
D3016	MTZJT-7712C	DIODE
D3018	MA165TA5	DIODE 1SS133T-77
D3019	MA165TA5	DIODE 1SS133T-77
D3501	MA165TA5	DIODE 1SS133T-77

Ref No.	Part No.	Description			
FUSES					
F840	2153.15H	FUSE		△	
F851	TR5-T1250	FUSE		△	
F852	TR5-T2000	FUSE		△	
F853	TR5-T2000	FUSE		△	
F8401	EYF52BC	FUSE HOLDER			
F8402	EYF52BC	FUSE HOLDER			
SOCKETS					
H1202	832AG11D-ESL	I.C.SOCKET			
TERMINALS AND LINKS					
JA.1	ERJ8GEY0R00	S.M.CAR .125W	5%	Ω	
JA.10	ERJ6GEY0R00	S.M.CARB 0.1W	5%	Ω	
JA.11	ERJ8GEY0R00	S.M.CAR .125W	5%	Ω	
JA.12	ERJ8GEY0R00	S.M.CAR .125W	5%	Ω	
JA.13	ERJ6GEY0R00	S.M.CARB 0.1W	5%	Ω	
JA.14	ERJ8GEY0R00	S.M.CAR .125W	5%	Ω	
JA.15	ERJ8GEY0R00	S.M.CAR .125W	5%	Ω	
JA.16	ERJ8GEY0R00	S.M.CAR .125W	5%	Ω	
JA.17	ERJ8GEY0R00	S.M.CAR .125W	5%	Ω	
JA.18	ERJ6GEY0R00	S.M.CARB 0.1W	5%	Ω	
JA.19	ERJ6GEY0R00	S.M.CARB 0.1W	5%	Ω	
JA.2	ERJ8GEY0R00	S.M.CAR .125W	5%	Ω	
JA.20	ERJ6GEY0R00	S.M.CARB 0.1W	5%	Ω	
JA.21	ERJ6GEY0R00	S.M.CARB 0.1W	5%	Ω	
JA.22	ERJ8GEY0R00	S.M.CAR .125W	5%	Ω	
JA.24	ERJ6GEY0R00	S.M.CARB 0.1W	5%	Ω	
JA.25	ERJ8GEY0R00	S.M.CAR .125W	5%	Ω	
JA.26	ERJ6GEY0R00	S.M.CARB 0.1W	5%	Ω	
JA.27	ERJ6GEY0R00	S.M.CARB 0.1W	5%	Ω	
JA.28	ERJ6GEY0R00	S.M.CARB 0.1W	5%	Ω	
JA.29	ERJ6GEY0R00	S.M.CARB 0.1W	5%	Ω	
JA.3	ERJ8GEY0R00	S.M.CAR .125W	5%	Ω	
JA.30	ERJ6GEY0R00	S.M.CARB 0.1W	5%	Ω	
JA.4	ERJ8GEY0R00	S.M.CAR .125W	5%	Ω	
JA.5	ERJ6GEY0R00	S.M.CARB 0.1W	5%	Ω	
JA.6	ERJ8GEY0R00	S.M.CAR .125W	5%	Ω	
JA.7	ERJ8GEY0R00	S.M.CAR .125W	5%	Ω	
JA.8	ERJ6GEY0R00	S.M.CARB 0.1W	5%	Ω	
JA.9	ERJ6GEY0R00	S.M.CARB 0.1W	5%	Ω	
JA33	ERJ8GEY0R00	S.M.CAR .125W	5%	Ω	
JA34	ERJ6GEY0R00	S.M.CARB 0.1W	5%	Ω	
JA35	ERJ8GEY0R00	S.M.CAR .125W	5%	Ω	
JA36	ERJ6GEY0R00	S.M.CARB 0.1W	5%	Ω	
JB1	ERJ6GEY0R00	S.M.CARB 0.1W	5%	Ω	
JB10	ERJ6GEY0R00	S.M.CARB 0.1W	5%	Ω	
JB11	ERJ6GEY0R00	S.M.CARB 0.1W	5%	Ω	
JB12	ERJ6GEY0R00	S.M.CARB 0.1W	5%	Ω	
JB13	ERJ6GEY0R00	S.M.CARB 0.1W	5%	Ω	
JB14	ERJ6GEY0R00	S.M.CARB 0.1W	5%	Ω	
JB15	ERJ6GEY0R00	S.M.CARB 0.1W	5%	Ω	
JB16	ERJ6GEY0R00	S.M.CARB 0.1W	5%	Ω	
JB17	ERJ6GEY0R00	S.M.CARB 0.1W	5%	Ω	
JB18	ERJ6GEY0R00	S.M.CARB 0.1W	5%	Ω	
JB19	ERJ6GEY0R00	S.M.CARB 0.1W	5%	Ω	
JB2	ERJ6GEY0R00	S.M.CARB 0.1W	5%	Ω	
JB20	ERJ6GEY0R00	S.M.CARB 0.1W	5%	Ω	
JB21	ERJ6GEY0R00	S.M.CARB 0.1W	5%	Ω	
JB22	ERJ6GEY0R00	S.M.CARB 0.1W	5%	Ω	
JB23	ERJ6GEY0R00	S.M.CARB 0.1W	5%	Ω	
JB24	ERJ6GEY0R00	S.M.CARB 0.1W	5%	Ω	
JB25	ERJ6GEY0R00	S.M.CARB 0.1W	5%	Ω	
JB26	ERJ6GEY0R00	S.M.CARB 0.1W	5%	Ω	
JB27	ERJ6GEY0R00	S.M.CARB 0.1W	5%	Ω	
JB28	ERJ6GEY0R00	S.M.CARB 0.1W	5%	Ω	
JB29	ERJ6GEY0R00	S.M.CARB 0.1W	5%	Ω	
JB3	ERJ6GEY0R00	S.M.CARB 0.1W	5%	Ω	
JB30	ERJ6GEY0R00	S.M.CARB 0.1W	5%	Ω	

Ref No.	Part No.	Description			
JB31	ERJ6GEY0R00	S.M.CARB 0.1W	5%	Ω	
JB32	ERJ6GEY0R00	S.M.CARB 0.1W	5%	Ω	
JB33	ERJ6GEY0R00	S.M.CARB 0.1W	5%	Ω	
JB34	ERJ6GEY0R00	S.M.CARB 0.1W	5%	Ω	
JB35	ERJ6GEY0R00	S.M.CARB 0.1W	5%	Ω	
JB36	ERJ6GEY0R00	S.M.CARB 0.1W	5%	Ω	
JB37	ERJ6GEY0R00	S.M.CARB 0.1W	5%	Ω	
JB38	ERJ6GEY0R00	S.M.CARB 0.1W	5%	Ω	
JB39	ERJ6GEY0R00	S.M.CARB 0.1W	5%	Ω	
JB40	ERJ6GEY0R00	S.M.CARB 0.1W	5%	Ω	
JB41	ERJ6GEY0R00	S.M.CARB 0.1W	5%	Ω	
JB42	ERJ6GEY0R00	S.M.CARB 0.1W	5%	Ω	
JB43	ERJ6GEY0R00	S.M.CARB 0.1W	5%	Ω	
JB44	ERJ6GEY0R00	S.M.CARB 0.1W	5%	Ω	
JB45	ERJ6GEY0R00	S.M.CARB 0.1W	5%	Ω	
JB46	ERJ6GEY0R00	S.M.CARB 0.1W	5%	Ω	
JB47	ERJ6GEY0R00	S.M.CARB 0.1W	5%	Ω	
JB48	ERJ6GEY0R00	S.M.CARB 0.1W	5%	Ω	
JB49	ERJ6GEY0R00	S.M.CARB 0.1W	5%	Ω	
JB50	ERJ6GEY0R00	S.M.CARB 0.1W	5%	Ω	
JB51	ERJ6GEY0R00	S.M.CARB 0.1W	5%	Ω	
JB52	ERJ6GEY0R00	S.M.CARB 0.1W	5%	Ω	
JB53	ERJ6GEY0R00	S.M.CARB 0.1W	5%	Ω	
JB54	ERJ6GEY0R00	S.M.CARB 0.1W	5%	Ω	
JB55	ERJ6GEY0R00	S.M.CARB 0.1W	5%	Ω	
JB56	ERJ6GEY0R00	S.M.CARB 0.1W	5%	Ω	
JB57	ERJ6GEY0R00	S.M.CARB 0.1W	5%	Ω	
JB58	ERJ6GEY0R00	S.M.CARB 0.1W	5%	Ω	
JB59	ERJ6GEY0R00	S.M.CARB 0.1W	5%	Ω	
JB6	ERJ6GEY0R00	S.M.CARB 0.1W	5%	Ω	
JB61	ERJ6GEY0R00	S.M.CARB 0.1W	5%	Ω	
JB62	ERJ6GEY0R00	S.M.CARB 0.1W	5%	Ω	
JB63	ERJ6GEY0R00	S.M.CARB 0.1W	5%	Ω	
JB64	ERJ6GEY0R00	S.M.CARB 0.1W	5%	Ω	
JB65	ERJ6GEY0R00	S.M.CARB 0.1W	5%	Ω	
JB66	ERJ6GEY0R00	S.M.CARB 0.1W	5%	Ω	
JB67	ERJ6GEY0R00	S.M.CARB 0.1W	5%	Ω	
JB68	ERJ6GEY0R00	S.M.CARB 0.1W	5%	Ω	
JB69	ERJ6GEY0R00	S.M.CARB 0.1W	5%	Ω	
JB7	ERJ6GEY0R00	S.M.CARB 0.1W	5%	Ω	
JB70	ERJ6GEY0R00	S.M.CARB 0.1W	5%	Ω	
JB71	ERJ6GEY0R00	S.M.CARB 0.1W	5%	Ω	
JB72	ERJ6GEY0R00	S.M.CARB 0.1W	5%	Ω	
JB73	ERJ6GEY0R00	S.M.CARB 0.1W	5%	Ω	
JB74	ERJ6GEY0R00	S.M.CARB 0.1W	5%	Ω	
JB75	ERJ6GEY0R00	S.M.CARB 0.1W	5%	Ω	
JB77	ERJ6GEY0R00	S.M.CARB 0.1W	5%	Ω	
JB79	ERJ6GEY0R00	S.M.CARB 0.1W	5%	Ω	
JB8	ERJ6GEY0R00	S.M.CARB 0.1W	5%	Ω	
JB80	ERJ6GEY0R00	S.M.CARB 0.1W	5%	Ω	
JB81	ERJ6GEY0R00	S.M.CARB 0.1W	5%	Ω	
JB9	ERJ6GEY0R00	S.M.CARB 0.1W	5%	Ω	
JK2301	TJB18644	AV TERMINAL			
JK3001	TJS8E007	21PIN TERMINAL			
JK3101	TJS8E007	21PIN TERMINAL			
JK3102	TJB16673	AV TERMINAL			
JSB1	ERJ6GEY0R00	S.M.CARB 0.1W	5%	Ω	
JSB12	ERJ6GEY0R00	S.M.CARB 0.1W	5%	Ω	
JSB13	ERJ6GEY0R00	S.M.CARB 0.1W	5%	Ω	
JSB14	ERJ6GEY0R00	S.M.CARB 0.1W	5%	Ω	
JSB2	ERJ6GEY0R00	S.M.CARB 0.1W	5%	Ω	
JSB4	EXCELSA35T	COIL			
JSE011	ERJ6GEY0R00	S.M.CARB 0.1W	5%	Ω	
JSE012	ERJ6GEY0R00	S.M.CARB 0.1W	5%	Ω	
JSE013	ERJ6GEY0R00	S.M.CARB 0.1W	5%	Ω	
JSE014	ERJ6GEY0R00	S.M.CARB 0.1W	5%	Ω	
JSE015	ERJ6GEY0R00	S.M.CARB 0.1W	5%	Ω	
JSE016	ERJ6GEY0R00	S.M.CARB 0.1W	5%	Ω	
JSE031	ERJ6GEY0R00	S.M.CARB 0.1W	5%	Ω	
JSE032	ERJ6GEY0R00	S.M.CARB 0.1W	5%	Ω	
J104	EXCELSA35T	COIL			
J106	EXCELSA35T	COIL			

Ref No.	Part No.	Description
J107	EXCELSA35T	COIL
J169	EXCELSA35T	COIL
COILS		
L001	TLT100K991R	COIL
L003	EXCELSA35T	COIL
L100	TLT181K991R	COIL
L111	TLT101K991R	COIL
L112	EXCELSA35T	COIL
L113	EXCELSA35T	COIL
L130	ELESN8R2KA	COIL
L132	ELESN8R2KA	COIL
L202	TLT068K991R	COIL
L251	EXCELSA35T	COIL
L301	TLT047K991R	COIL
L302	EXCEMT101BT	COIL
L303	EXCEMT101BT	COIL
L304	EXCEMT101BT	COIL
L601	TLT047K991R	COIL
L602	EXCELD35V	COIL
L603	TLT047K991R	COIL
L604	EXCELD35V	COIL
L606	TLT015K991R	COIL
L607	EXCELSA35T	COIL
L701	ELC10D006	COIL
L801	EXCELSA24T	COIL
L802	TLT022K991R	COIL
L804	ELESN4R7KA	COIL
L805	298-82858001	COIL
L841	ELF18D490F	COIL
L851	EXCELD35V	COIL
L852	EXCELSA35T	COIL
L853	ELEIE470KA	COIL
L854	ELEIN470KA	COIL
L855	ELEIN470KA	COIL
L856	ELEIN470KA	COIL
L1051	TLT331K991R	COIL
L1201	TLT047K991R	COIL
L1202	TLT047K991R	COIL
L1203	TLT047K991R	COIL
L1204	EXCELD35V	COIL
L2101	TLT100K991R	COIL
L2102	TLT039K991R	COIL
L2103	EXCELSA35T	COIL
L2104	EXCELSA35T	COIL
L3151	EXCEMT101BT	COIL
L3152	EXCEMT101BT	COIL
L3153	EXCEMT101BT	COIL
L3154	EXCEMT101BT	COIL
L3155	ELEBT6R8KA	COIL
L3156	ELEBT6R8KA	COIL
L3158	EXCELSA39V	COIL
L3501	EXCELD35V	COIL
L3502	EXCELD35V	COIL
L3503	ELESN4R7KA	COIL
L3504	EXCELSA35T	COIL
TRANSISTORS		
Q201	BC847B	TRANSISTOR OR 2SD601ATX
Q202	BC847B	TRANSISTOR OR 2SD601ATX
Q251	2SD1328STX	TRANSISTOR
Q252	2SD1328STX	TRANSISTOR
Q301	BC857B	TRANSISTOR OR 2SB709ATX
Q302	BC847B	TRANSISTOR OR 2SD601ATX
Q303	BC857B	TRANSISTOR OR 2SB709ATX
Q304	BC847B	TRANSISTOR OR 2SD601ATX
Q305	BC857B	TRANSISTOR OR 2SB709ATX
Q306	BC847B	TRANSISTOR OR 2SD601ATX
Q307	BC847B	TRANSISTOR OR 2SD601ATX
Q308	BC847B	TRANSISTOR OR 2SD601ATX

Ref No.	Part No.	Description
Q309	BC847B	TRANSISTOR OR 2SD601ATX
Q310	BC847B	TRANSISTOR OR 2SD601ATX
Q311	BC847B	TRANSISTOR OR 2SD601ATX
Q351	2SA1767	TRANSISTOR
Q352	2SA1767	TRANSISTOR
Q353	2SA1767	TRANSISTOR
Q451	BC847B	TRANSISTOR OR 2SD601ATX
Q501	BC847B	TRANSISTOR OR 2SD601ATX
Q502	BC847B	TRANSISTOR OR 2SD601ATX
Q503	2SD836-AL	TRANSISTOR
Q504	BC847B	TRANSISTOR OR 2SD601ATX
Q552	2SC1473-RN	TRANSISTOR
Q701	BC857B	TRANSISTOR OR 2SB709ATX
Q802	S2000NLBMA	TRANSISTOR
Q851	2SD1273PLB	TRANSISTOR OR 2SD2396/JM3
Q852	TFD312SOF632	DIODE
Q1202	BC847B	TRANSISTOR OR 2SD601ATX
Q1205	BC847B	TRANSISTOR OR 2SD601ATX
Q1206	BC847B	TRANSISTOR OR 2SD601ATX
Q1207	BC847B	TRANSISTOR OR 2SD601ATX
Q1208	BC857B	TRANSISTOR OR 2SB709ATX
Q1211	BC547B	TRANSISTOR
Q1212	BC847B	TRANSISTOR OR 2SD601ATX
Q1213	BC847B	TRANSISTOR OR 2SD601ATX
Q2101	BC860B	TRANSISTOR
Q2102	BC860B	TRANSISTOR
Q2301	BC857B	TRANSISTOR OR 2SB709ATX
Q2302	BC857B	TRANSISTOR OR 2SB709ATX
Q2305	2SD1328STX	TRANSISTOR
Q2306	2SD1328STX	TRANSISTOR
Q2307	BC860B	TRANSISTOR
Q2308	BC857B	TRANSISTOR OR 2SB709ATX
Q2309	BC860B	TRANSISTOR
Q2310	BC860B	TRANSISTOR
Q3001	2SC1318-S	TRANSISTOR
Q3004	BC847B	TRANSISTOR OR 2SD601ATX
Q3005	BC847B	TRANSISTOR OR 2SD601ATX
Q3006	2SC1318-S	TRANSISTOR
Q3011	BC857B	TRANSISTOR OR 2SB709ATX
Q3012	2SD1328STX	TRANSISTOR
Q3013	2SD1328STX	TRANSISTOR
RESISTOR		
RL1201	TSE1885-1	RELAY
R100	ERJ6GEYJ103	S.M.CARB 0.1W 5% 10KΩ
R101	ERJ6GEYJ331	S.M.CARB 0.1W 5% 330Ω
R102	ERJ6GEYJ103	S.M.CARB 0.1W 5% 10KΩ
R103	ERJ6GEYJ331	S.M.CARB 0.1W 5% 330Ω
R107	ERJ6GEYJ103	S.M.CARB 0.1W 5% 10KΩ
R109	ERJ6GEYJ103	S.M.CARB 0.1W 5% 10KΩ
R112	ERJ6GEYOR00	S.M.CARB 0.1W 5% 0Ω
R114	ERJ6GEYJ223	S.M.CARB 0.1W 5% 22KΩ
R117	ERJ6GEYJ103	S.M.CARB 0.1W 5% 10KΩ
R130	ERJ6GEYJ101	S.M.CARB 0.1W 5% 100Ω
R131	ERJ6GEYJ101	S.M.CARB 0.1W 5% 100Ω
R132	ERJ6GEYJ223	S.M.CARB 0.1W 5% 22KΩ
R133	ERJ6GEYJ101	S.M.CARB 0.1W 5% 100Ω
R134	ERJ6GEYOR00	S.M.CARB 0.1W 5% 0Ω
R136	ERJ6GEYJ393	S.M.CARB 0.1W 5% 39KΩ
R138	ERJ6GEYJ103	S.M.CARB 0.1W 5% 10KΩ
R201	ERJ6GEYJ471	S.M.CARB 0.1W 5% 470Ω
R203	ERJ6GEYOR00	S.M.CARB 0.1W 5% 0Ω
R204	ERJ6GEYJ102	S.M.CARB 0.1W 5% 1KΩ
R205	ERJ6GEYJ391	S.M.CARB 0.1W 5% 390Ω
R206	ERJ6GEYJ680	S.M.CARB 0.1W 5% 68Ω
R207	ERJ6GEYJ123	S.M.CARB 0.1W 5% 12KΩ
R208	ERJ6GEYJ182	S.M.CARB 0.1W 5% 1K8Ω
R210	ERJ6GEYOR00	S.M.CARB 0.1W 5% 0Ω
R251	ERJ6GEYJ101	S.M.CARB 0.1W 5% 100Ω
R252	ERJ6GEYJ152	S.M.CARB 0.1W 5% 1K5Ω
R253	ERJ6GEYJ103	S.M.CARB 0.1W 5% 10KΩ
R254	ERJ6GEYJ101	S.M.CARB 0.1W 5% 100Ω

Ref No.	Part No.	Description					
R255	ERJ6GEYJ103	S.M.CARB	0.1W	5%	10KΩ		
R256	ERJ6GEYJ471	S.M.CARB	0.1W	5%	470Ω		
R258	ERJ6GEYJ152	S.M.CARB	0.1W	5%	1K5Ω		
R260	ERJ6GEYJ103	S.M.CARB	0.1W	5%	10KΩ		
R261	ERJ6GEYJ471	S.M.CARB	0.1W	5%	470Ω		
R262	ERJ6GEYJ103	S.M.CARB	0.1W	5%	10KΩ		
R265	ERD25TJ2R2	CARBON	0.25W	5%	2R2Ω		
R266	ERD25TJ2R2	CARBON	0.25W	5%	2R2Ω		
R267	ERF7ZK4R7	WOUND	7W	10%	4R7Ω	Δ	
R271	ERJ6GEYJ103	S.M.CARB	0.1W	5%	10KΩ		
R272	ERF7ZK5R6	WOUND	7W	10%	5R6Ω	Δ	
R273	ERD25TJ273	CARBON	0.25W	5%	27KΩ		
R301	ERJ6GEYJ750	S.M.CARB	0.1W	5%	75Ω		
R302	ERJ6GEYJ471	S.M.CARB	0.1W	5%	470Ω		
R303	ERJ6GEYJ471	S.M.CARB	0.1W	5%	470Ω		
R304	ERJ6GEYJ471	S.M.CARB	0.1W	5%	470Ω		
R305	ERJ6GEYJ750	S.M.CARB	0.1W	5%	75Ω		
R306	ERJ6GEYJ471	S.M.CARB	0.1W	5%	470Ω		
R307	ERJ6GEYJ471	S.M.CARB	0.1W	5%	470Ω		
R308	ERJ6GEYJ471	S.M.CARB	0.1W	5%	470Ω		
R309	ERJ6GEYJ750	S.M.CARB	0.1W	5%	75Ω		
R310	ERJ6GEYJ471	S.M.CARB	0.1W	5%	470Ω		
R311	ERJ6GEYJ471	S.M.CARB	0.1W	5%	470Ω		
R312	ERJ6GEYJ471	S.M.CARB	0.1W	5%	470Ω		
R313	ERJ6GEYJ101	S.M.CARB	0.1W	5%	100Ω		
R314	ERJ6GEYJ332	S.M.CARB	0.1W	5%	3K3Ω		
R315	ERJ6GEYJ332	S.M.CARB	0.1W	5%	3K3Ω		
R316	ERJ6GEYJ332	S.M.CARB	0.1W	5%	3K3Ω		
R321	ERJ6GEYJ473	S.M.CARB	0.1W	5%	47KΩ		
R322	ERJ6GEYJ473	S.M.CARB	0.1W	5%	47KΩ		
R323	ERJ6GEYJ103	S.M.CARB	0.1W	5%	10KΩ		
R324	ERJ6GEYJ104	S.M.CARB	0.1W	5%	100KΩ		
R354	ERJ6GEYJ102	S.M.CARB	0.1W	5%	1KΩ		
R355	ERJ6GEYJ102	S.M.CARB	0.1W	5%	1KΩ		
R356	ERJ6GEYJ102	S.M.CARB	0.1W	5%	1KΩ		
R372	ERQ12AJ121	FUSIBLE	0.5W	5%	120Ω	Δ	
R373	ERJ6GEYJ220	S.M.CARB	0.1W	5%	22Ω		
R375	ERJ6GEYJ684	S.M.CARB	0.1W	5%	680KΩ		
R376	ERJ6GEYJ183	S.M.CARB	0.1W	5%	18KΩ		
R452	ERJ6GEYJ472	S.M.CARB	0.1W	5%	4K7Ω		
R453	ERJ6GEYJ104	S.M.CARB	0.1W	5%	100KΩ		
R455	ERJ6GEYJ222	S.M.CARB	0.1W	5%	2K2Ω		
R456	ERJ6GEYJ123	S.M.CARB	0.1W	5%	12KΩ		
R457	ERJ6GEYJ103	S.M.CARB	0.1W	5%	10KΩ		
R458	ERD25TJ1R5	CARBON	0.25W	5%	1R5Ω		
R459	ERJ6GEYJ680	S.M.CARB	0.1W	5%	68Ω		
R460	ERJ6GEYJ513	S.M.CARB	0.1W	5%	51KΩ		
R461	ERDS1TJ471	CARBON	0.5W	5%	470Ω		
R462	ERJ6GEYJ472	S.M.CARB	0.1W	5%	4K7Ω		
R463	ERJ6GEYJ472	S.M.CARB	0.1W	5%	4K7Ω		
R465	ERJ6GEYJ101	S.M.CARB	0.1W	5%	100Ω		
R466	ERO25CKF1801	METAL	0.25W	1%	1K8Ω	Δ	
R470	ERD25TJ512	CARBON	0.25W	5%	5K1Ω		
R471	ERDS1TJ152	CARBON	0.5W	5%	1K5Ω		
R472	ERDS1TJ4R7	CARBON	0.5W	5%	4R7Ω		
R501	ERJ6GEYJ331	S.M.CARB	0.1W	5%	330Ω		
R502	ERJ6GEYJ560	S.M.CARB	0.1W	5%	56Ω		
R503	ERJ6GEYJ273	S.M.CARB	0.1W	5%	27KΩ		
R504	ERJ6GEYJ101	S.M.CARB	0.1W	5%	100Ω		
R506	ERD25TJ560	CARBON	0.25W	5%	56Ω		
R507	ERQ14AJW3R3	FUSIBLE	0.25W	5%	3R3Ω	Δ	
R509	ERDS1TJ152	CARBON	0.5W	5%	1K5Ω		
R510	ERDS1TJ152	CARBON	0.5W	5%	1K5Ω		
R511	ERJ6GEYJ104	S.M.CARB	0.1W	5%	100KΩ		
R512	ERJ6GEYJ472	S.M.CARB	0.1W	5%	4K7Ω		
R513	ERJ6GEYJ123	S.M.CARB	0.1W	5%	12KΩ		
R514	ERJ6GEYJ123	S.M.CARB	0.1W	5%	12KΩ		
R551	ERW2PKR47	WIREWOUND	2W	10%	R47Ω	Δ	
R553	ERG1SJ152	METAL	1W	5%	1K5Ω		
R558	ERDS1TJ124	CARBON	0.5W	5%	120KΩ		
R561	ERJ6GEYJ563	S.M.CARB	0.1W	5%	56KΩ		
R562	ERJ6GEYJ225	SM.CARB0.125W		5%	2M2Ω		

Ref No.	Part No.	Description					
R563	ERJ6GEYJ225	SM.CARB0.125W		5%	2M2Ω		
R567	ERJ6GEYJ274	S.M.CARB	0.1W	5%	270KΩ		
R601	ERJ6GEYJ151	S.M.CARB	0.1W	5%	150Ω		
R602	ERJ6GEYJ151	S.M.CARB	0.1W	5%	150Ω		
R603	ERJ6GEYJ750	S.M.CARB	0.1W	5%	75Ω		
R604	ERJ6GEY0R00	S.M.CARB	0.1W	5%	0Ω		
R605	ERJ6GEYJ183	S.M.CARB	0.1W	5%	18KΩ		
R606	ERJ6GEYJ472	S.M.CARB	0.1W	5%	4K7Ω		
R607	ERJ6GEYJ103	S.M.CARB	0.1W	5%	10KΩ		
R608	ERJ6GEYJ101	S.M.CARB	0.1W	5%	100Ω		
R609	ERJ6GEYJ101	S.M.CARB	0.1W	5%	100Ω		
R610	ERJ6GEYJ473	S.M.CARB	0.1W	5%	47KΩ		
R611	ERJ6GEYJ102	S.M.CARB	0.1W	5%	1KΩ		
R612	ERJ6GEYJ123	S.M.CARB	0.1W	5%	12KΩ		
R613	ERJ6GEYJ271	S.M.CARB	0.1W	5%	270Ω		
R614	ERJ6GEYJ470	S.M.CARB	0.1W	5%	47Ω		
R615	ERJ6GEYJ333	S.M.CARB	0.1W	5%	33KΩ		
R616	ERJ6GEYJ153	S.M.CARB	0.1W	5%	15KΩ		
R618	ERJ6GEYJ151	S.M.CARB	0.1W	5%	150Ω		
R619	ERJ6GEYJ472	S.M.CARB	0.1W	5%	4K7Ω		
R622	ERJ6GEY0R00	S.M.CARB	0.1W	5%	0Ω		
R623	ERJ6GEYJ821	S.M.CARB	0.1W	5%	820Ω		
R701	ERQ12AJ101	FUSIBLE	0.5W	5%	100Ω	Δ	
R703	ERG2FJ821	METAL	2W	5%	820Ω	Δ	
R704	ERJ6GEYJ563	S.M.CARB	0.1W	5%	56KΩ		
R705	ERJ6GEYJ104	S.M.CARB	0.1W	5%	100KΩ		
R708	ERJ6GEYJ393	S.M.CARB	0.1W	5%	39KΩ		
R709	ERJ6GEYJ393	S.M.CARB	0.1W	5%	39KΩ		
R710	ERJ6GEYJ273	S.M.CARB	0.1W	5%	27KΩ		
R712	ERJ6GEYJ472	S.M.CARB	0.1W	5%	4K7Ω		
R713	ERG1SJ101	METAL	1W	5%	100Ω		
R801	ERG3FJ682H	METAL	3W	5%	6K8Ω	Δ	
R802	ERG2FJ472	METAL	2W	5%	4K7Ω	Δ	
R803	ERX12SJWR47	METAL	12W	5%	R47		
R804	ERJ6GEYJ682	S.M.CARB	0.1W	5%	6K8Ω		
R805	ERJ6GEYJ221	S.M.CARB	0.1W	5%	220Ω		
R807	ERO25CKF1201	METAL	0.25W	1%	1K2Ω	Δ	
R810	ERD25TJ103	CARBON	0.25W	5%	10KΩ		
R811	EVMEASA00B33	CONTROL			3KΩ		
R812	ERDS1TJ220	CARBON	0.5W	5%	22Ω		
R813	ERD50FJ274	CARBON	0.5W	5%	270KΩ		
R814	ERF7ZK2R7	WOUND	7W	20%	2R7Ω	Δ	
R815	ERDS1TJ563	CARBON	0.5W	5%	56KΩ		
R817	ERG3FJ470	METAL	3W	5%	47Ω	Δ	
R818	ERD50FJ104	CARBON	0.5W	5%	100KΩ		
R819	ERD50FJ184	CARBON	0.5W	5%	180KΩ		
R820	ERD75TAJ825	CARBON	0.75W	5%	8M2Ω	Δ	
R841	ERC12ZGK335D	SOLID	0.5W	10%	3M3Ω		
R852	ERJ6GEYJ271	S.M.CARB	0.1W	5%	270Ω		
R853	ERJ6GEYJ101	S.M.CARB	0.1W	5%	100Ω		
R854	ERDS1TJ474	CARBON	0.5W	5%	470KΩ		
R855	ERG2FJ223	METAL	2W	5%	22KΩ	Δ	
R856	ERJ6GEYJ102	S.M.CARB	0.1W	5%	1KΩ		
R857	ERG2SJS100H	METAL	2W	5%	10Ω	Δ	
R1201	ERJ6GEYJ271	S.M.CARB	0.1W	5%	270Ω		
R1202	ERJ6GEYJ101	S.M.CARB	0.1W	5%	100Ω		
R1203	ERJ6GEYJ101	S.M.CARB	0.1W	5%	100Ω		
R1204	ERJ6GEYJ101	S.M.CARB	0.1W	5%	100Ω		
R1205	ERJ6GEYJ101	S.M.CARB	0.1W	5%	100Ω		
R1206	ERJ6GEYJ101	S.M.CARB	0.1W	5%	100Ω		
R1208	ERJ6GEYJ223	S.M.CARB	0.1W	5%	22KΩ		
R1209	ERJ6GEYJ472	S.M.CARB	0.1W	5%	4K7Ω		
R1210	ERJ6GEYJ472	S.M.CARB	0.1W	5%	4K7Ω		
R1212	ERJ6GEYJ103	S.M.CARB	0.1W	5%	10KΩ		
R1213	ERJ6GEYJ103	S.M.CARB	0.1W	5%	10KΩ		
R1214	ERJ6GEYJ472	S.M.CARB	0.1W	5%	4K7Ω		
R1215	ERJ6GEYJ101	S.M.CARB	0.1W	5%	100Ω		
R1216	ERJ6GEYJ101	S.M.CARB	0.1W	5%	100Ω		
R1217	ERJ6GEYJ101	S.M.CARB	0.1W	5%	100Ω		
R1218	ERJ6GEYJ472	S.M.CARB	0.1W	5%	4K7Ω		
R1219	ERJ6GEYJ472	S.M.CARB	0.1W	5%	4K7Ω		
R1220	ERJ6GEYJ472	S.M.CARB	0.1W	5%	4K7Ω		

Ref No.	Part No.	Description
R1221	ERJ6GEYJ103	S.M.CARB 0.1W 5% 10KΩ
R1222	ERJ6GEYJ103	S.M.CARB 0.1W 5% 10KΩ
R1224	ERJ6GEYJ103	S.M.CARB 0.1W 5% 10KΩ
R1225	ERJ6GEYJ472	S.M.CARB 0.1W 5% 4K7Ω
R1226	ERJ6GEYJ472	S.M.CARB 0.1W 5% 4K7Ω
R1227	ERJ6GEYJ472	S.M.CARB 0.1W 5% 4K7Ω
R1229	ERJ6GEY0R00	S.M.CARB 0.1W 5% 0Ω
R1230	ERJ6GEY0R00	S.M.CARB 0.1W 5% 0Ω
R1231	ERJ6GEYJ472	S.M.CARB 0.1W 5% 4K7Ω
R1232	ERJ6GEYJ103	S.M.CARB 0.1W 5% 10KΩ
R1233	ERJ6GEYJ472	S.M.CARB 0.1W 5% 4K7Ω
R1235	ERJ6GEYJ103	S.M.CARB 0.1W 5% 10KΩ
R1236	ERJ6GEYJ472	S.M.CARB 0.1W 5% 4K7Ω
R1237	ERJ6GEYJ103	S.M.CARB 0.1W 5% 10KΩ
R1238	ERJ6GEYJ393	S.M.CARB 0.1W 5% 39KΩ
R1239	ERJ6GEYJ392	S.M.CARB 0.1W 5% 3K9Ω
R1240	ERJ6GEYJ392	S.M.CARB 0.1W 5% 3K9Ω
R1241	ERJ6GEYJ101	S.M.CARB 0.1W 5% 100Ω
R1242	ERJ6GEYJ101	S.M.CARB 0.1W 5% 100Ω
R1244	ERJ6GEY0R00	S.M.CARB 0.1W 5% 0Ω
R1245	ERJ6GEYJ222	S.M.CARB 0.1W 5% 2K2Ω
R1246	ERJ6GEYJ103	S.M.CARB 0.1W 5% 10KΩ
R1247	ERJ6GEYJ103	S.M.CARB 0.1W 5% 10KΩ
R1249	ERJ6GEYJ472	S.M.CARB 0.1W 5% 4K7Ω
R1250	ERJ6GEYJ103	S.M.CARB 0.1W 5% 10KΩ
R1251	ERJ6GEYJ393	S.M.CARB 0.1W 5% 39KΩ
R1252	ERX1SJ3R3	METAL 1W 5% 3R3Ω
R1253	ERJ6GEYJ103	S.M.CARB 0.1W 5% 10KΩ
R1254	ERJ6GEYJ104	S.M.CARB 0.1W 5% 100KΩ
R1255	ERJ6GEYJ104	S.M.CARB 0.1W 5% 100KΩ
R1256	ERJ6GEYJ102	S.M.CARB 0.1W 5% 1KΩ
R1257	ERJ6GEYJ101	S.M.CARB 0.1W 5% 100Ω
R1258	ERJ6GEYJ472	S.M.CARB 0.1W 5% 4K7Ω
R1260	ERDS1FJ121	CARBON 0.5W 5% 120Ω ▲
R1261	ERJ6GEYJ392	S.M.CARB 0.1W 5% 3K9Ω
R1262	ERJ6GEYJ682	S.M.CARB 0.1W 5% 6K8Ω
R1263	ERJ6GEYJ223	S.M.CARB 0.1W 5% 22KΩ
R1264	ERJ6GEYJ222	S.M.CARB 0.1W 5% 2K2Ω
R1265	ERJ6GEYJ152	S.M.CARB 0.1W 5% 1K5Ω
R1266	ERJ6GEYJ223	S.M.CARB 0.1W 5% 22KΩ
R1277	ERDS1TJ151	CARBON 0.5W 5% 150Ω
R2101	ERJ6GEYJ471	S.M.CARB 0.1W 5% 470Ω
R2102	ERJ6GEYJ561	S.M.CARB 0.1W 5% 560Ω
R2103	ERJ6GEYJ471	S.M.CARB 0.1W 5% 470Ω
R2104	ERJ6GEYJ471	S.M.CARB 0.1W 5% 470Ω
R2105	ERJ6GEYJ561	S.M.CARB 0.1W 5% 560Ω
R2106	ERJ6GEYJ183	S.M.CARB 0.1W 5% 18KΩ
R2107	ERJ6GEYJ471	S.M.CARB 0.1W 5% 470Ω
R2108	ERJ6GEYJ101	S.M.CARB 0.1W 5% 100Ω
R2109	ERJ6GEYJ101	S.M.CARB 0.1W 5% 100Ω
R2110	ERJ6GEYJ103	S.M.CARB 0.1W 5% 10KΩ
R2111	ERJ6GEYJ102	S.M.CARB 0.1W 5% 1KΩ
R2301	ERJ6GEYJ222	S.M.CARB 0.1W 5% 2K2Ω
R2302	ERJ6GEYJ222	S.M.CARB 0.1W 5% 2K2Ω
R2303	ERJ6GEYJ101	S.M.CARB 0.1W 5% 100Ω
R2304	ERJ6GEYJ101	S.M.CARB 0.1W 5% 100Ω
R2313	ERJ6GEYJ101	S.M.CARB 0.1W 5% 100Ω
R2314	ERJ6GEYJ101	S.M.CARB 0.1W 5% 100Ω
R2315	ERJ6GEYJ473	S.M.CARB 0.1W 5% 47KΩ
R2316	ERJ6GEYJ104	S.M.CARB 0.1W 5% 100KΩ
R2318	ERJ6GEYJ104	S.M.CARB 0.1W 5% 100KΩ
R2321	ERJ6GEYJ103	S.M.CARB 0.1W 5% 10KΩ
R2322	ERJ6GEYJ471	S.M.CARB 0.1W 5% 470Ω
R2323	ERJ6GEYJ103	S.M.CARB 0.1W 5% 10KΩ
R2324	ERJ6GEYJ471	S.M.CARB 0.1W 5% 470Ω
R2325	ERJ6GEYJ273	S.M.CARB 0.1W 5% 27KΩ
R2326	ERJ6GEYJ471	S.M.CARB 0.1W 5% 470Ω
R2327	ERJ6GEYJ471	S.M.CARB 0.1W 5% 470Ω
R2328	ERJ6GEYJ473	S.M.CARB 0.1W 5% 47KΩ
R2329	ERJ6GEYJ222	S.M.CARB 0.1W 5% 2K2Ω
R2330	ERJ6GEYJ222	S.M.CARB 0.1W 5% 2K2Ω
R2331	ERJ6GEYJ223	S.M.CARB 0.1W 5% 22KΩ

Ref No.	Part No.	Description
R2332	ERJ6GEYJ471	S.M.CARB 0.1W 5% 470Ω
R2333	ERJ6GEYJ471	S.M.CARB 0.1W 5% 470Ω
R2334	ERJ6GEY0R00	S.M.CARB 0.1W 5% 0Ω
R2335	ERJ6GEY0R00	S.M.CARB 0.1W 5% 0Ω
R2651	ERG2FJ221	METAL 2W 5% 220Ω ▲
R2652	ERG2FJ221	METAL 2W 5% 220Ω ▲
R2653	ERDS1TJ151	CARBON 0.5W 5% 150Ω
R2654	ERDS1TJ151	CARBON 0.5W 5% 150Ω
R3001	ERJ6GEYJ153	S.M.CARB 0.1W 5% 15KΩ
R3002	ERJ6GEYJ101	S.M.CARB 0.1W 5% 100Ω
R3003	ERJ6GEYJ101	S.M.CARB 0.1W 5% 100Ω
R3004	ERJ6GEYJ153	S.M.CARB 0.1W 5% 15KΩ
R3005	ERJ6GEYJ470	S.M.CARB 0.1W 5% 47Ω
R3006	ERJ6GEYJ470	S.M.CARB 0.1W 5% 47Ω
R3007	ERJ6GEYJ750	S.M.CARB 0.1W 5% 75Ω
R3008	ERJ6GEYJ104	S.M.CARB 0.1W 5% 100KΩ
R3009	ERJ6GEYJ104	S.M.CARB 0.1W 5% 100KΩ
R3010	ERJ6GEYJ561	S.M.CARB 0.1W 5% 560Ω
R3011	ERJ6GEYJ101	S.M.CARB 0.1W 5% 100Ω
R3012	ERJ6GEYJ101	S.M.CARB 0.1W 5% 100Ω
R3013	ERJ6GEYJ561	S.M.CARB 0.1W 5% 560Ω
R3014	ERJ6GEY0R00	S.M.CARB 0.1W 5% 0Ω
R3015	ERJ6GEY0R00	S.M.CARB 0.1W 5% 0Ω
R3016	ERJ6GEYJ103	S.M.CARB 0.1W 5% 10KΩ
R3017	ERJ6GEYJ102	S.M.CARB 0.1W 5% 1KΩ
R3019	ERJ6GEYJ471	S.M.CARB 0.1W 5% 470Ω
R3020	ERJ6GEYJ103	S.M.CARB 0.1W 5% 10KΩ
R3022	ERD2FCG560	CARBON 2W 2% 56Ω
R3024	ERJ6GEYJ471	S.M.CARB 0.1W 5% 470Ω
R3025	ERJ6GEYJ103	S.M.CARB 0.1W 5% 10KΩ
R3026	ERJ6GEYJ471	S.M.CARB 0.1W 5% 470Ω
R3027	ERJ6GEYJ680	S.M.CARB 0.1W 5% 68Ω
R3029	ERJ6GEYJ680	S.M.CARB 0.1W 5% 68Ω
R3030	ERJ6GEYJ103	S.M.CARB 0.1W 5% 10KΩ
R3032	ERJ6GEYJ680	S.M.CARB 0.1W 5% 68Ω
R3034	ERJ6GEYJ103	S.M.CARB 0.1W 5% 10KΩ
R3036	ERJ6GEYJ220	S.M.CARB 0.1W 5% 22Ω
R3037	ERJ6GEYJ750	S.M.CARB 0.1W 5% 75Ω
R3038	ERD2FCG100	CARB 2W 2% 10Ω
R3039	ERJ6GEYJ101	S.M.CARB 0.1W 5% 100Ω
R3040	ERJ6GEYJ101	S.M.CARB 0.1W 5% 100Ω
R3041	ERJ6GEYJ153	S.M.CARB 0.1W 5% 15KΩ
R3042	ERJ6GEYJ682	S.M.CARB 0.1W 5% 6K8Ω
R3043	ERD2FCG100	CARB 2W 2% 10Ω
R3044	ERJ6GEYJ101	S.M.CARB 0.1W 5% 100Ω
R3045	ERJ6GEYJ471	S.M.CARB 0.1W 5% 470Ω
R3046	ERJ6GEYJ101	S.M.CARB 0.1W 5% 100Ω
R3047	ERJ6GEYJ680	S.M.CARB 0.1W 5% 68Ω
R3048	ERJ6GEYJ102	S.M.CARB 0.1W 5% 1KΩ
R3049	ERJ6GEYJ680	S.M.CARB 0.1W 5% 68Ω
R3050	ERJ6GEYJ101	S.M.CARB 0.1W 5% 100Ω
R3051	ERJ6GEYJ101	S.M.CARB 0.1W 5% 100Ω
R3052	ERJ6GEYJ101	S.M.CARB 0.1W 5% 100Ω
R3053	ERJ6GEYJ101	S.M.CARB 0.1W 5% 100Ω
R3054	ERJ6GEYJ101	S.M.CARB 0.1W 5% 100Ω
R3055	ERJ6GEYJ101	S.M.CARB 0.1W 5% 100Ω
R3056	ERJ6GEYJ101	S.M.CARB 0.1W 5% 100Ω
R3057	ERJ6GEYJ101	S.M.CARB 0.1W 5% 100Ω
R3058	ERJ6GEYJ153	S.M.CARB 0.1W 5% 15KΩ
R3059	ERJ6GEYJ153	S.M.CARB 0.1W 5% 15KΩ
R3060	ERJ6GEYJ470	S.M.CARB 0.1W 5% 47Ω
R3062	ERJ6GEYJ750	S.M.CARB 0.1W 5% 75Ω
R3063	ERJ6GEYJ750	S.M.CARB 0.1W 5% 75Ω
R3064	ERJ6GEYJ103	S.M.CARB 0.1W 5% 10KΩ
R3065	ERJ6GEYJ104	S.M.CARB 0.1W 5% 100KΩ
R3066	ERJ6GEYJ104	S.M.CARB 0.1W 5% 100KΩ
R3067	ERJ6GEYJ273	S.M.CARB 0.1W 5% 27KΩ
R3068	ERJ6GEYJ103	S.M.CARB 0.1W 5% 10KΩ
R3069	ERJ6GEYJ103	S.M.CARB 0.1W 5% 10KΩ
R3070	ERJ6GEYJ750	S.M.CARB 0.1W 5% 75Ω
R3071	ERJ6GEYJ470	S.M.CARB 0.1W 5% 47Ω
R3150	ERJ6GEYJ750	S.M.CARB 0.1W 5% 75Ω

Ref No.	Part No.	Description
R3151	ERJ6GEYJ750	S.M.CARB 0.1W 5% 75Ω
R3152	ERJ6GEYJ750	S.M.CARB 0.1W 5% 75Ω
R3153	ERJ6GEYJ750	S.M.CARB 0.1W 5% 75Ω
R3155	ERJ6GEYJ101	S.M.CARB 0.1W 5% 100Ω
R3156	ERJ6GEYJ101	S.M.CARB 0.1W 5% 100Ω
R3158	ERJ6GEYJ750	S.M.CARB 0.1W 5% 75Ω
R3502	ERJ6GEYJ101	S.M.CARB 0.1W 5% 100Ω
R3504	ERJ6GEYJ101	S.M.CARB 0.1W 5% 100Ω
R3505	ERJ6GEY0R00	S.M.CARB 0.1W 5% 0Ω
R3508	ERJ6GEYJ183	S.M.CARB 0.1W 5% 18KΩ
R3511	ERJ6GEYJ103	S.M.CARB 0.1W 5% 10KΩ
R3512	ERJ6GEYJ472	S.M.CARB 0.1W 5% 4K7Ω

SWITCHES

S.351	0330550049	CRT SOCKET
S801	ESB91232A	SWITCH ▲

DIFFERENCES FOR MODEL TX-28MD3F

Ref No.	Part No.	Description
MISCELLANEOUS COMPONENTS		
3)	TNP117070AT	Y PC.B ▲
4)	TLK8E05125	DEGAUSS COIL ▲
5)	VP17005-32	CRT FIXING SCREW
6)	A66ECF50X32	CRT ▲
7)	TKY8E190	CABINET ▲
8)	TBX8E041	POWER BUTTON
11)	TBM8E1640	MODEL LABEL
12)	TKU8E00330	BACK COVER ▲
14)	TNP8EE008AT	E PC.B. ▲
	SVM100	COIL
	TBM173052	BADGE
	TPC8E4601	OUTER CARTON
	TPD8E639	CUSHION TOP
	TPD8E640	CUSHION BOTTOM
CAPACITORS		
C251	ECA1HM100GB	ELECT 50V 10pF
C252	ECUV1H223KBX	S.M.CAP 50V 22nF
C254	222236516334	FILM 160V 330nF
C256	ECUV1H223KBX	S.M.CAP 50V 22nF
C258	ECA1HM100GB	ELECT 50V 10pF
C259	222236516334	FILM 160V 330nF
C262	ECEA1HN2R2	ELECT 50V 2.2μF
C265	ECEA1HN2R2	ELECT 50V 2.2μF
C364	ECUV1H103ZFX	S.M.CAP 50V 10nF
C366	ECA1CM100GB	ELECT 16V 10pF
C455	ECEA1VGE222	ELECT 35V 2200μF
C457	ECUV1H223KBX	S.M.CAP 50V 22nF
C459	222236516224	FILM 160V 220nF
C551	222237544182	CAPACITOR 1.8nF
C552	ECWH15H102H	FILM 1500V 100pF
C554	ECWF2H514J	FILM 500V 510nF ▲
C556	ECQM4333J	FILM 400V 33nF
C559	ECWF2H684J	FILM 500V 680nF ▲
C560	ECEA2GGE2R2	ELECT 400V 2.2μF
C606	ECUV1H040CCX	S.M.CAP 50V 4pF
C607	ECUV1H040CCX	S.M.CAP 50V 4pF
C625	ECEA1HNR47	ELECT 50V 0.47μF
C701	ECEA1HGE101	ELECT 50V 100μF
C703	ECEA1HGE100	ELECT 50V 10μF
C820	ECOS2GG181NG	ELECT 400V 180μF ▲
C857	ECEA2EU101	ELECT 250V 100μF
C861	ECOS2EA221AB	ELECT 250V 220μF
C901	ECUV1H030CCX	S.M.CAP 50V 30pF
C902	ECA1VM101GB	ELECT 35V 100pF
C903	ECA1CM470GB	ELECT 16V 47μF
C904	ECUV1H103ZFX	S.M.CAP 50V 10nF
C905	ECA1HM4R7GB	ELECT 50V 4.7μF

Ref No.	Part No.	Description
S1201	EVQ23405R	SWITCH
S1202	EVQ23405R	SWITCH
S1203	EVQ23405R	SWITCH
S1204	EVQ23405R	SWITCH
S1205	EVQ23405R	SWITCH
TRANSFORMERS		
T501	5270103200	TRANSFORMER
T1201	ETP35KAN61ZU	TRANSFORMER
FILTERS		
X100	EFGA6R5MB3	FILTER
X601	TSS2169-B	CRYSTAL
X1201	TSS120M2	CRYSTAL
X2101	4730007158	CRYSTAL

Ref No.	Part No.	Description
C906	ECUV1H471KBX	S.M.CAP 50V 470pF
C907	ECUV1H271JCX	S.M.CAP 50V 270pF
C908	ECUV1H151JCX	S.M.CAP 50V 150pF
C909	ECKC2H472J	CERAMIC 500V 4.7nF ▲
C910	ECKC2H472J	CERAMIC 500V 4.7nF ▲
C911	ECUV1H151JCX	S.M.CAP 50V 150pF
C912	ECEA2CU100	ELECT 160V 10μF
C913	ECA1HM101GB	ELECT 50V 100pF
C914	ECA1HM101GB	ELECT 50V 100pF
C915	ECA1CM471GB	ELECT 16V 470pF
C916	ECEA2CU100	ELECT 160V 10μF
DIODES		
D707	MTZJT-778.2C	DIODE
D901	MA165TA5	DIODE 1SS133T-77
D902	MA165TA5	DIODE 1SS133T-77
D904	MA165TA5	DIODE 1SS133T-77
D906	RLS72TE-11	DIODE OR PMLL4148
D1210	MA165TA5	DIODE 1SS133T-77
INTEGRATED CIRCUITS		
IC1202	27C010-002AL	EPROM
IC1203	X24LM0401EJ	EAROM
TERMINALS AND LINKS		
JA.1	ERJ6GEY0R00	S.M.CARB 0.1W 5% 0Ω
JA.2	ERJ6GEY0R00	S.M.CARB 0.1W 5% 0Ω
COILS		
L352	SDL-4101	COIL
L353	SDL-4101	COIL
L354	SDL-4101	COIL
L552	ELH5L437	COIL
L553	ELC08D055	COIL
L554	297-23293	COIL
L901	EXCELSA24T	COIL
L902	EXCELSA24T	COIL
TRANSISTORS		
Q551	2SD1577LB	TRANSISTOR
Q901	BC847B	TRANSISTOR OR 2SD601ATX
Q902	BC847B	TRANSISTOR OR 2SD601ATX
Q903	BC847B	TRANSISTOR OR 2SD601ATX
Q904	BC857B	TRANSISTOR OR 2SB709ATX
Q905	BC847B	TRANSISTOR OR 2SD601ATX
Q906	BC847B	TRANSISTOR OR 2SD601ATX
Q907	BC857B	TRANSISTOR OR 2SB709ATX

Ref No.	Part No.	Description
Q908	2SB940APLB	TRANSISTOR
Q909	2SD1264APLB	TRANSISTOR
RESISTOR		
R.925	ERJ6GEY0R00	S.M.CARB 0.1W 5% 0Ω
R.926	ERJ6GEY0R00	S.M.CARB 0.1W 5% 0Ω
R257	ERJ6GEYJ100	S.M.CARB 0.1W 5% 10Ω
R259	ERJ6GEYJ100	S.M.CARB 0.1W 5% 10Ω
R351	ERJ6GEYJ102	S.M.CARB 0.1W 5% 1KΩ
R352	ERJ6GEYJ102	S.M.CARB 0.1W 5% 1KΩ
R353	ERJ6GEYJ102	S.M.CARB 0.1W 5% 1KΩ
R357	ERG1FJ683P	METAL 1W 5% 68KΩ ▲
R358	ERG1FJ683P	METAL 1W 5% 68KΩ ▲
R359	ERG1FJ683P	METAL 1W 5% 68KΩ ▲
R363	ERD25TJ103	CARBON 0.25W 5% 10KΩ
R364	ERD25TJ103	CARBON 0.25W 5% 10KΩ
R365	ERD25TJ103	CARBON 0.25W 5% 10KΩ
R366	ERDS1TJ152	CARBON 0.5W 5% 1K5Ω
R367	ERDS1TJ152	CARBON 0.5W 5% 1K5Ω
R368	ERDS1TJ152	CARBON 0.5W 5% 1K5Ω
R369	ERD25TJ203	CARBON 0.25W 5% 20KΩ
R370	ERJ6GEYJ822	S.M.CARB 0.1W 5% 8K2Ω
R374	ERD25TJ274	CARBON 0.25W 5% 270KΩ
R377	ERQ1CJP4R7	FUSIBLE 1W 5% 4R7Ω ▲
R381	ERJ6GEYJ102	S.M.CARB 0.1W 5% 1KΩ
R382	ERJ6GEYJ102	S.M.CARB 0.1W 5% 1KΩ
R383	ERJ6GEYJ102	S.M.CARB 0.1W 5% 1KΩ
R451	ERJ6GEYJ393	S.M.CARB 0.1W 5% 39KΩ
R464	ERW12PKR68	WIREWOUND0.5W 10% R68Ω ▲
R467	ERO25CKF1801	METAL 0.25W 1% 1K8Ω ▲
R554	ERQ14AJW101	METAL 0.25W 5% 100Ω ▲
R564	ERJ6GEYJ103	S.M.CARB 0.1W 5% 10KΩ
R566	ERJ6GEYJ682	S.M.CARB 0.1W 5% 6K8Ω
R702	ERQ12HJ220	METAL 0.5W 5% 22Ω ▲
R706	ERJ6GEYJ103	S.M.CARB 0.1W 5% 10KΩ
R707	ERJ6GEYJ102	S.M.CARB 0.1W 5% 1KΩ
R711	ERJ6GEYJ102	S.M.CARB 0.1W 5% 1KΩ
R808	232266296706	THERMISTOR
R809	ERO25CKF1332	METAL 0.25W 1% 13KΩ ▲

Ref No.	Part No.	Description
R901	ERJ6GEYJ562	S.M.CARB 0.1W 5% 5K6Ω
R902	ERJ6GEYJ562	S.M.CARB 0.1W 5% 5K6Ω
R903	ERJ6GEYJ562	S.M.CARB 0.1W 5% 5K6Ω
R904	ERJ6GEYJ222	S.M.CARB 0.1W 5% 2K2Ω
R905	ERJ6GEYJ681	S.M.CARB 0.1W 5% 680Ω
R906	ERJ6GEYJ223	S.M.CARB 0.1W 5% 22KΩ
R907	ERJ6GEYJ472	S.M.CARB 0.1W 5% 4K7Ω
R908	ERJ6GEYJ471	S.M.CARB 0.1W 5% 470Ω
R909	ERJ6GEYJ102	S.M.CARB 0.1W 5% 1KΩ
R910	ERJ6GEYJ101	S.M.CARB 0.1W 5% 100Ω
R911	ERJ6GEYJ152	S.M.CARB 0.1W 5% 1K5Ω
R913	ERJ6GEYJ183	S.M.CARB 0.1W 5% 18KΩ
R914	ERJ6GEYJ222	S.M.CARB 0.1W 5% 2K2Ω
R915	ERJ6GEYJ182	S.M.CARB 0.1W 5% 1K8Ω
R916	ERJ6GEYJ221	S.M.CARB 0.1W 5% 220Ω
R917	ERJ6GEYJ121	S.M.CARB 0.1W 5% 120Ω
R919	ERQ14AJ390	FUSIBLE 0.25W 5% 39Ω ▲
R920	ERQ14AJ390	FUSIBLE 0.25W 5% 39Ω ▲
R921	ERD25TJ471	CARBON 0.25W 5% 470Ω
R922	ERD25TJ393	CARBON 0.25W 5% 39KΩ
R923	ERD25TJ393	CARBON 0.25W 5% 39KΩ
R924	ERDS1FJ390	CARBON 0.5W 5% 39Ω ▲
R927	ERD25TJ471	CARBON 0.25W 5% 470Ω
R928	ERD25TJ5R6	CARBON 0.25W 5% 5R6Ω
R929	ERDS1FJ471	CARBON 0.5W 5% 470Ω ▲
R930	ERD25TJ5R6	CARBON 0.25W 5% 5R6Ω
R931	ERDS1FJ390	CARBON 0.5W 5% 39Ω ▲
R932	ERDS1FJ101	CARBON 0.5W 5% 100Ω ▲
R933	ERJ6GEYJ103	S.M.CARB 0.1W 5% 10KΩ
R934	ERJ6GEYJ222	S.M.CARB 0.1W 5% 2K2Ω
R935	ERQ14AJ3R9	FUSIBLE 0.25W 5% 3R9Ω ▲
R936	ERQ1CJP331	METAL 1W 5% 330Ω ▲
R937	ERQ14AJ100	METAL 0.25W 5% 10Ω ▲
R3154	ERJ6GEYJ153	S.M.CARB 0.1W 5% 15KΩ
R3157	ERJ6GEYJ153	S.M.CARB 0.1W 5% 15KΩ
TRANSFORMERS		
T551	ZTFH44011A	F.B.T. ▲
T801	TLP8E1002	TRANSFORMER ▲

DIFFERENCES FOR MODEL TX-25MD3F

Ref No.	Part No.	Description
MISCELLANEOUS COMPONENTS		
3)	TNP117070AT	Y P.C.B. ▲
4)	TLK8E05120	DEGAUSS COIL ▲
5)	VP17005-32	CRT FIXING SCREW
6)	A59ECF50X32	CRT ▲
7)	TKY8E180	CABINET ▲
8)	TBX8E042	POWER BUTTON
11)	TBM8E1637	MODEL LABEL
12)	TKU8E00190	REAR COVER ▲
14)	TNP8EE008AE	E P.C.B. ▲
	SVM100	COIL
	TBM173052	BADGE
	TPC8E4606	OUTER CARTON
	TPD8E608-1	CUSHION-SET
	TPD8E609	CUSHION-SET
	TQB8E2278	INST BOOK ▲
	TQB8E2279	INST BOOK ▲
CAPACITORS		
C251	ECA1HM100GB	ELECT 50V 10pF
C252	ECUY1H563KBX	S.M.CAP 50V 56nF
C254	222236516334	FILM 160V 330nF
C256	ECUY1H563KBX	S.M.CAP 50V 56nF
C258	ECA1HM100GB	ELECT 50V 10pF
C259	222236516334	FILM 160V 330nF

Ref No.	Part No.	Description
C262	ECEA1HN2R2	ELECT 50V 2.2μF
C265	ECEA1HN2R2	ELECT 50V 2.2μF
C269	ECA1CM100GB	ELECT 16V 10pF
C364	ECUV1H103ZFX	S.M.CAP 50V 10nF
C366	ECA1CM100GB	ELECT 16V 10pF
C455	ECEA1VGE222	ELECT 35V 2200μF
C457	ECUV1H223KBX	S.M.CAP 50V 22nF
C459	222236516224	FILM 160V 220nF
C551	222237544182	CAPACITOR 1.8nF
C552	ECWH15H102H	FILM 1500V 100pF
C554	ECWF2H514J	FILM 500V 510nF ▲
C556	ECQM4333JC	FILM 400V 33nF
C559	ECWF2H684J	FILM 500V 680nF ▲
C560	ECEA2GGE2R2	ELECT 400V 2.2μF
C606	ECUV1H040CCX	S.M.CAP 50V 4pF
C607	ECUV1H040CCX	S.M.CAP 50V 4pF
C625	ECEA1HNR47	ELECT 50V 0.47μF
C701	ECEA1HGE101	ELECT 50V 100μF
C703	ECEA1HGE100	ELECT 50V 10μF
C820	ECOS2GG181NG	ELECT 400V 180μF ▲
C857	ECEA2EU101	ELECT 250V 100μF
C861	ECOS2EA221AB	ELECT 250V 220μF
C901	ECUV1H030CCX	S.M.CAP 50V 30pF
C902	ECA1VM101GB	ELECT 35V 100pF
C903	ECA1CM470GB	ELECT 16V 47μF
C904	ECUV1H103ZFX	S.M.CAP 50V 10nF
C905	ECA1HM4R7GB	ELECT 50V 4.7μF
C906	ECUV1H471KBX	S.M.CAP 50V 470pF

Ref No.	Part No.	Description
C907	ECUV1H271JCX	S.M.CAP 50V 270pF
C908	ECUV1H151JCX	S.M.CAP 50V 150pF
C909	ECKC2H472J	CERAMIC 500V 4.7nF Δ
C910	ECKC2H472J	CERAMIC 500V 4.7nF Δ
C911	ECUV1H151JCX	S.M.CAP 50V 150pF
C912	ECEA2CU100	ELECT 160V 10 μ F
C913	ECA1HM101GB	ELECT 50V 100pF
C914	ECA1HM101GB	ELECT 50V 100pF
C915	ECA1CM471GB	ELECT 16V 470pF
C916	ECEA2CU100	ELECT 160V 10 μ F

DIODES

D252	MA165TA5	DIODE 1SS133T-77
D707	MTZJT-778.2C	DIODE
D901	MA165TA5	DIODE 1SS133T-77
D902	MA165TA5	DIODE 1SS133T-77
D904	MA165TA5	DIODE 1SS133T-77
D906	RLS72TE-11	DIODE OR PMLL4148
D1210	MA165TA5	DIODE 1SS133T-77

INTEGRATED CIRCUITS

IC1202	27C010-002AK	EPROM
IC1203	X24LM0401E	EAROM

TERMINALS AND LINKS

JA.1	ERJ6GEY0R00	S.M.CARB 0.1W	5%	0 Ω
JA.2	ERJ6GEY0R00	S.M.CARB 0.1W	5%	0 Ω
JSE035	ERJ6GEY0R00	S.M.CARB 0.1W	5%	0 Ω
JSE037	ERJ6GEY0R00	S.M.CARB 0.1W	5%	0 Ω

COILS

L352	SDL-4101	COIL
L353	SDL-4101	COIL
L354	SDL-4101	COIL
L552	ELH5L437	COIL
L553	ELC08D055	COIL
L554	297-23293	COIL
L901	EXCELSA24T	COIL
L902	EXCELSA24T	COIL

TRANSISTORS

Q253	BC847B	TRANSISTOR OR 2SD601ATX
Q551	2SD1577LB	TRANSISTOR
Q901	BC847B	TRANSISTOR OR 2SD601ATX
Q902	BC847B	TRANSISTOR OR 2SD601ATX
Q903	BC847B	TRANSISTOR OR 2SD601ATX
Q904	BC857B	TRANSISTOR OR 2SB709ATX
Q905	BC847B	TRANSISTOR OR 2SD601ATX
Q906	BC847B	TRANSISTOR OR 2SD601ATX
Q907	BC857B	TRANSISTOR OR 2SB709ATX
Q908	2SB940APLB	TRANSISTOR
Q909	2SD1264APLB	TRANSISTOR

RESISTOR

R.925	ERJ6GEY0R00	S.M.CARB 0.1W	5%	0 Ω
R.926	ERJ6GEY0R00	S.M.CARB 0.1W	5%	0 Ω
R257	ERJ6GEYJ100	S.M.CARB 0.1W	5%	10 Ω
R259	ERJ6GEYJ100	S.M.CARB 0.1W	5%	10 Ω
R263	ERJ6GEYJ104	S.M.CARB 0.1W	5%	100K Ω
R264	ERJ6GEYJ473	S.M.CARB 0.1W	5%	47K Ω
R268	ERJ6GEYJ103	S.M.CARB 0.1W	5%	10K Ω
R269	ERJ6GEYJ273	S.M.CARB 0.1W	5%	27K Ω
R351	ERJ6GEYJ102	S.M.CARB 0.1W	5%	1K Ω
R352	ERJ6GEYJ102	S.M.CARB 0.1W	5%	1K Ω

Ref No.	Part No.	Description
R353	ERJ6GEYJ102	S.M.CARB 0.1W 5% 1K Ω
R357	ERG1FJ683P	METAL 1W 5% 68K Ω Δ
R358	ERG1FJ683P	METAL 1W 5% 68K Ω Δ
R359	ERG1FJ683P	METAL 1W 5% 68K Ω Δ
R363	ERD25TJ103	CARBON 0.25W 5% 10K Ω
R364	ERD25TJ103	CARBON 0.25W 5% 10K Ω
R365	ERD25TJ103	CARBON 0.25W 5% 10K Ω
R366	ERDS1TJ152	CARBON 0.5W 5% 1K5 Ω
R367	ERDS1TJ152	CARBON 0.5W 5% 1K5 Ω
R368	ERDS1TJ152	CARBON 0.5W 5% 1K5 Ω
R369	ERD25TJ203	CARBON 0.25W 5% 20K Ω
R370	ERJ6GEYJ822	S.M.CARB 0.1W 5% 8K2 Ω
R374	ERD25TJ274	CARBON 0.25W 5% 270K Ω
R377	ERQ1CJP4R7	FUSIBLE 1W 5% 4R7 Ω Δ
R381	ERJ6GEYJ102	S.M.CARB 0.1W 5% 1K Ω
R382	ERJ6GEYJ102	S.M.CARB 0.1W 5% 1K Ω
R383	ERJ6GEYJ102	S.M.CARB 0.1W 5% 1K Ω
R451	ERJ6GEYJ393	S.M.CARB 0.1W 5% 39K Ω
R464	ERW12PKR68	WIREWOUND0.5W 10% 68 Ω Δ
R467	ERO25CKF1801	METAL 0.25W 1% 1K8 Ω Δ
R554	ERQ14AJW101	METAL 0.25W 5% 100 Ω Δ
R564	ERJ6GEYJ103	S.M.CARB 0.1W 5% 10K Ω
R566	ERJ6GEYJ682	S.M.CARB 0.1W 5% 6K8 Ω
R702	ERQ12HJ220	METAL 0.5W 5% 22 Ω Δ
R706	ERJ6GEYJ103	S.M.CARB 0.1W 5% 10K Ω
R707	ERJ6GEYJ102	S.M.CARB 0.1W 5% 1K Ω
R711	ERJ6GEYJ102	S.M.CARB 0.1W 5% 1K Ω
R808	232266296706	THERMISTOR
R809	ERO25CKF1332	METAL 0.25W 1% 13K Ω Δ
R901	ERJ6GEYJ562	S.M.CARB 0.1W 5% 5K6 Ω
R902	ERJ6GEYJ562	S.M.CARB 0.1W 5% 5K6 Ω
R903	ERJ6GEYJ562	S.M.CARB 0.1W 5% 5K6 Ω
R904	ERJ6GEYJ222	S.M.CARB 0.1W 5% 2K2 Ω
R905	ERJ6GEYJ681	S.M.CARB 0.1W 5% 680 Ω
R906	ERJ6GEYJ223	S.M.CARB 0.1W 5% 22K Ω
R907	ERJ6GEYJ472	S.M.CARB 0.1W 5% 4K7 Ω
R908	ERJ6GEYJ471	S.M.CARB 0.1W 5% 470 Ω
R909	ERJ6GEYJ102	S.M.CARB 0.1W 5% 1K Ω
R910	ERJ6GEYJ101	S.M.CARB 0.1W 5% 100 Ω
R911	ERJ6GEYJ152	S.M.CARB 0.1W 5% 1K5 Ω
R913	ERJ6GEYJ183	S.M.CARB 0.1W 5% 18K Ω
R914	ERJ6GEYJ222	S.M.CARB 0.1W 5% 2K2 Ω
R915	ERJ6GEYJ182	S.M.CARB 0.1W 5% 1K8 Ω
R916	ERJ6GEYJ221	S.M.CARB 0.1W 5% 220 Ω
R917	ERJ6GEYJ121	S.M.CARB 0.1W 5% 120 Ω
R919	ERQ14AJ390	FUSIBLE 0.25W 5% 39 Ω Δ
R920	ERQ14AJ390	FUSIBLE 0.25W 5% 39 Ω Δ
R921	ERD25TJ471	CARBON 0.25W 5% 470 Ω
R922	ERD25TJ393	CARBON 0.25W 5% 39K Ω
R923	ERD25TJ393	CARBON 0.25W 5% 39K Ω
R924	ERDS1FJ390	CARBON 0.5W 5% 39 Ω Δ
R927	ERD25TJ471	CARBON 0.25W 5% 470 Ω
R928	ERD25TJ5R6	CARBON 0.25W 5% 5R6 Ω
R929	ERDS1FJ471	CARBON 0.5W 5% 470 Ω Δ
R930	ERD25TJ5R6	CARBON 0.25W 5% 5R6 Ω
R931	ERDS1FJ390	CARBON 0.5W 5% 39 Ω Δ
R932	ERDS1FJ101	CARBON 0.5W 5% 100 Ω Δ
R933	ERJ6GEYJ103	S.M.CARB 0.1W 5% 10K Ω
R934	ERJ6GEYJ222	S.M.CARB 0.1W 5% 2K2 Ω
R935	ERQ14AJ3R9	FUSIBLE 0.25W 5% 3R9 Ω Δ
R936	ERQ1CJP331	METAL 1W 5% 330 Ω Δ
R937	ERQ14AJ100	METAL 0.25W 5% 10 Ω Δ
R3154	ERJ6GEYJ183	S.M.CARB 0.1W 5% 18K Ω
R3157	ERJ6GEYJ183	S.M.CARB 0.1W 5% 18K Ω

TRANSFORMERS

T551	KFT4AA098F	F.B.T.	Δ
T801	TLP8E1002	TRANSFORMER	Δ

DIFFERENCES FOR MODEL TX-21MD3F

Ref No.	Part No.	Description	
MISCELLANEOUS COMPONENTS			
3)	TNP117069AD	Y P.C.B.	△
4)	TLK8E05117	DEGAUSS COIL	△
5)	VP15005-35	CRT FIXING SCREW	
6)	A51ECQ51X01	CRT	△
7)	TKY8E170	CABINET	△
8)	TBX8E041	POWER BUTTON	
11)	TBM8E1634	MODEL LABEL	
12)	TKU8E00260	REAR COVER	△
14)	TNP8EE008AB	E P.C.B.	△
	TBM153022	PANASONIC BADGE	
	TPC8E4605	OUTER CARTON	
	TPD8E606-1	CUSHION	
	TPD8E607-1	CUSHION	
CAPACITORS			
C251	ECA1EM101GB	ELECT	25V 1μF
C252	ECUY1H563KBX	S.M.CAP	50V 56nF
C254	222236516474	FILM	160V 470nF
C256	ECUY1H563KBX	S.M.CAP	50V 56nF
C258	ECA1EM101GB	ELECT	25V 1μF
C259	222236516474	FILM	160V 470nF
C262	ECEA1HN010	ELECT	50V 1μF
C265	ECEA1HN010	ELECT	50V 1μF
C269	ECA1CM100GB	ELECT	16V 10pF
C455	ECA1VM222GE	ELECT	35V 2.2nF
C457	ECUV1H103KBX	S.M.CAP	50V 10nF
C459	222236516154	FILM	160V 150nF
C463	ECQB1H222J	FILM	50V 2200pF
C551	ECWH12H272J	CERAMIC	1250V 2.7nF
C552	ECWH12H102J	FILM	1250V 1nF
C556	ECQF4273JZH	FILM	400V 27nF
C559	ECWF2H474J	FILM	500V 470nF
C625	ECEA1HNR22	ELECT	50V 0.22μF
C701	ECEA1HU101	ELECT	50V 100μF
C703	ECA1HM100GB	ELECT	50V 10pF
C820	ECOS2GA151CB	ELECT	400V 150pF
C857	ECA2CM101E	ELECT	160V 100μF
C861	ECA2CGE221	ELECT	160V 220μF
DIODES			
D252	MA165TA5	DIODE 1SS133T-77	
INTEGRATED CIRCUITS			
IC1202	27C010-002AH	EPROM	
IC1203	X24LM0401EF	EAROM	
TERMINALS AND LINKS			
JSE035	ERJ6GEY0R00	S.M.CARB	0.1W 5% 0Ω
JSE037	ERJ6GEY0R00	S.M.CARB	0.1W 5% 0Ω

Ref No.	Part No.	Description	
COILS			
L552	ELH5L429	COIL	
TRANSISTORS			
Q253	BC847B	TRANSISTOR OR 2SD601ATX	
Q551	BU2506DXLB	TRANSISTOR	
RESISTOR			
R257	ERJ6GEYJ2R2	SM.CARB0.125W	5% 2R2Ω
R259	ERJ6GEYJ2R2	SM.CARB0.125W	5% 2R2Ω
R263	ERJ6GEYJ104	S.M.CARB 0.1W	5% 100KΩ
R264	ERJ6GEYJ473	S.M.CARB 0.1W	5% 47KΩ
R268	ERJ6GEYJ103	S.M.CARB 0.1W	5% 10KΩ
R269	ERJ6GEYJ273	S.M.CARB 0.1W	5% 27KΩ
R351	ERJ6GEYJ182	S.M.CARB 0.1W	5% 1K8Ω
R352	ERJ6GEYJ182	S.M.CARB 0.1W	5% 1K8Ω
R353	ERJ6GEYJ182	S.M.CARB 0.1W	5% 1K8Ω
R357	ERG1FJ563	METAL 1W	5% 56KΩ △
R358	ERG2FJ563	METAL 2W	5% 56KΩ △
R359	ERG1FJ563	METAL 1W	5% 56KΩ △
R363	ERDS1TJ103	CARBON 0.5W	5% 10KΩ
R364	ERDS1TJ103	CARBON 0.5W	5% 10KΩ
R365	ERDS1TJ103	CARBON 0.5W	5% 10KΩ
R366	ERDS1TJ222	CARBON 0.5W	5% 2K2Ω
R367	ERDS1TJ222	CARBON 0.5W	5% 2K2Ω
R368	ERDS1TJ222	CARBON 0.5W	5% 2K2Ω
R369	ERD25TJ223	CARBON 0.25W	5% 22KΩ
R370	ERD25TJ103	CARBON 0.25W	5% 10KΩ
R374	ERDS1TJ274	CARBON 0.5W	5% 270KΩ
R377	ERQ12HJ1R2	METAL 0.5W	5% 1R2Ω △
R378	ERJ6GEY0R00	S.M.CARB 0.1W	5% 0Ω
R379	ERJ6GEY0R00	S.M.CARB 0.1W	5% 0Ω
R380	ERJ6GEY0R00	S.M.CARB 0.1W	5% 0Ω
R451	ERJ6GEYJ273	S.M.CARB 0.1W	5% 27KΩ
R464	ERW12PK1R5	WIRE 12W	10% 1R5Ω
R467	ERO25CKF1201	METAL 0.25W	1% 1K2Ω △
R564	ERJ6GEYJ623	SM.CARB0.125W	5% 62KΩ
R566	ERJ6GEYJ473	S.M.CARB 0.1W	5% 47KΩ
R702	ERQ12HJ330	METAL 0.5W	5% 33Ω △
R706	ERJ6GEYJ272	S.M.CARB 0.1W	5% 2K7Ω
R707	ERJ6GEYJ122	S.M.CARB 0.1W	5% 1K2Ω
R711	ERJ6GEYJ681	S.M.CARB 0.1W	5% 680Ω
R808	232266296319	THERMISTOR	
R809	ERO25CKF1302	METAL 0.25W	1% 13KΩ △
R3154	ERJ6GEYJ183	S.M.CARB 0.1W	5% 18KΩ
R3157	ERJ6GEYJ183	S.M.CARB 0.1W	5% 18KΩ
TRANSFORMERS			
T551	ZTFH44010A	F.B.T.	△
T801	TLP8E1001	TRANSFORMER	△

SCHEMATIC DIAGRAM FOR MODELS

TX-28MD3F TX-25MD3F







TX-21MD3F

(Euro-2M Chassis)

IMPORTANT SAFETY NOTICE

Components identified by  mark have special characteristics important for safety. When replacing any of these components, use only manufacturer's specified parts.

Notes

- RESISTOR**
All resistors are carbon 1/4W resistor, unless marked as follows:
Unit of resistance is OHM (Ω) (K=1,000, M=1,000,000).
- CAPACITORS**
All capacitors are ceramic 50V, unless marked as follows:
Unit of capacitance is μ F, unless otherwise stated.
- COIL**
Unit of inductance is μ H, unless otherwise stated.
- Components marked 'L' on the schematic diagram shows leadless parts.
- TEST POINT**
 : Test Point position
- EARTH SYMBOL**
 : Chassis Earth (Cold)  : Line Earth (Hot)
- VOLTAGE MEASUREMENT**
Voltage is measured by a DC voltmeter.
Measurement conditions are as follows:
Power source AC 220V-240V, 50Hz
Receiving Signal Colour Bar signal (RF)
All customer controls Maximum position
-  : Indicates the Video signal path
 : Indicates the Audio signal path
 : Indicates the Vertical/Horizontal signal path
- This schematic diagram is the latest at the time of printing and is subject to change without notice.

Remarks

- The Power Circuit contains a circuit area which uses a separate power supply to isolate the earth connection. The circuit is defined by HOT and COLD indications in the schematic diagram. All circuits, except the Power Circuit, are COLD. Take the following precautions:

Precautions

- Do not touch the hot part, or the hot and cold parts at the same time, as you are liable to a shock hazard.
- Do not short-circuit the hot and cold circuits as electrical components may be damaged.
- Do not connect an instrument, such as an oscilloscope, to the hot and cold circuits simultaneously, as this may cause fuse failure. Connect the earth of the instruments to the earth connection of the circuit being measured.
- Make sure to disconnect the power plug before removing the chassis.

ZEICHENERKLÄRUNG FÜR MODELL

TX-28MD3F TX-25MD3F







TX-21MD3F

(Euro-2M Chassis)

WICHTIGER SICHERHEITSHINWEIS

Teile, die mit einem Hinweis  gekennzeichnet sind, sind wichtig für die Sicherheit. Sollte ein Auswechseln erforderlich sein, sind unbedingt Originalteile einzusetzen.

Anmerkung

- WIDERSTÄNDE**
Alle 1/4Watt Widerstände sind Kohlewiderstände, Abweichungen sind folgt gekennzeichnet.
Die Maßeinheit ist OHM (Ω) (K=1,000 M=1,000,000)
- KONDENSATOREN**
Alle Kondensatoren sind Keramikausführungen
Spannungsfestigkeit 50V. Abweichungen sind wie folgt gekennzeichnet.
Die Maßeinheit ist μ F, wenn keine anderen Bezeichnungen genannt sind
- SPULEN**
Die Maßeinheit ist μ H, Abweichungen sind gekennzeichnet.
Mit 'L' gekennzeichnete Teile sind ohne Anschlußdrähte.
- TESTPUNKE**
 : Kennzeichnung der Testpunktpositio
- MASSE SYMBOL**
 : Erdung am Chassis  : Erdung an Masse-Leitung
- SPANNUNGSMESSUNG**
Spannungsmessungen sind mit einem DC-Voltmeter durchzuführen. Die Meßbedingungen sind folgende:
Netzspannung AC 220V-240V 50Hz
Wiedergabe Signal Farbbalken-Testbild
Alle übrigen Einstellungen für Benutzer Sollangaben
-  : Videosignalweg
 : Audiosignalweg
 : Signalweg für Hor/Vert. Synchronsignale

- Anderungen im Laufe der Fertigung sind möglich.

Bemerkungen

- Das Schaltnetzteil enthält Bereiche, die direkt mit dem Netz verbunden sind. Diese Bereiche sind im Schalplan mit HOT gekennzeichnet. Alle anderen Schaltungen sind mit COLD gekennzeichnet und haben keine direkte Verbindung mit dem Netz.

Für den netzverbundenen Bereich (HOT) sind folgende Vorsichtsmaßnahmen zu beachten:

- Weder die Leitungen im heißen noch Leitungen im kalten Bereich gleichzeitig berühren. Es besteht die Gefahr eines elektrischen Schlages.
- Keinesfalls die Leitungen im heißen Bereich mit denen im kalten Bereich verbinden oder kurzschließen. Dies kann zur Zerstörung von Bauteilen oder Sicherungen führen. Außerdem ist die elektrische Betriebssicherheit des Gerätes nicht mehr gegeben.
- Keine Messinstrumente gleichzeitig an Leitungen im heißen und kalten Bereich anschließen. Sicherungen könnten zerstört werden. Die Erde des Messinstrumentes immer mit der des zu prüfenden Schaltkreises verbinden.
- Vor Ausbau des Chassis, Stecker aus der Netzsteckdose ziehen.

B-BOARD TX-28MD3F / TX-25MD3F / TX-21MD3F

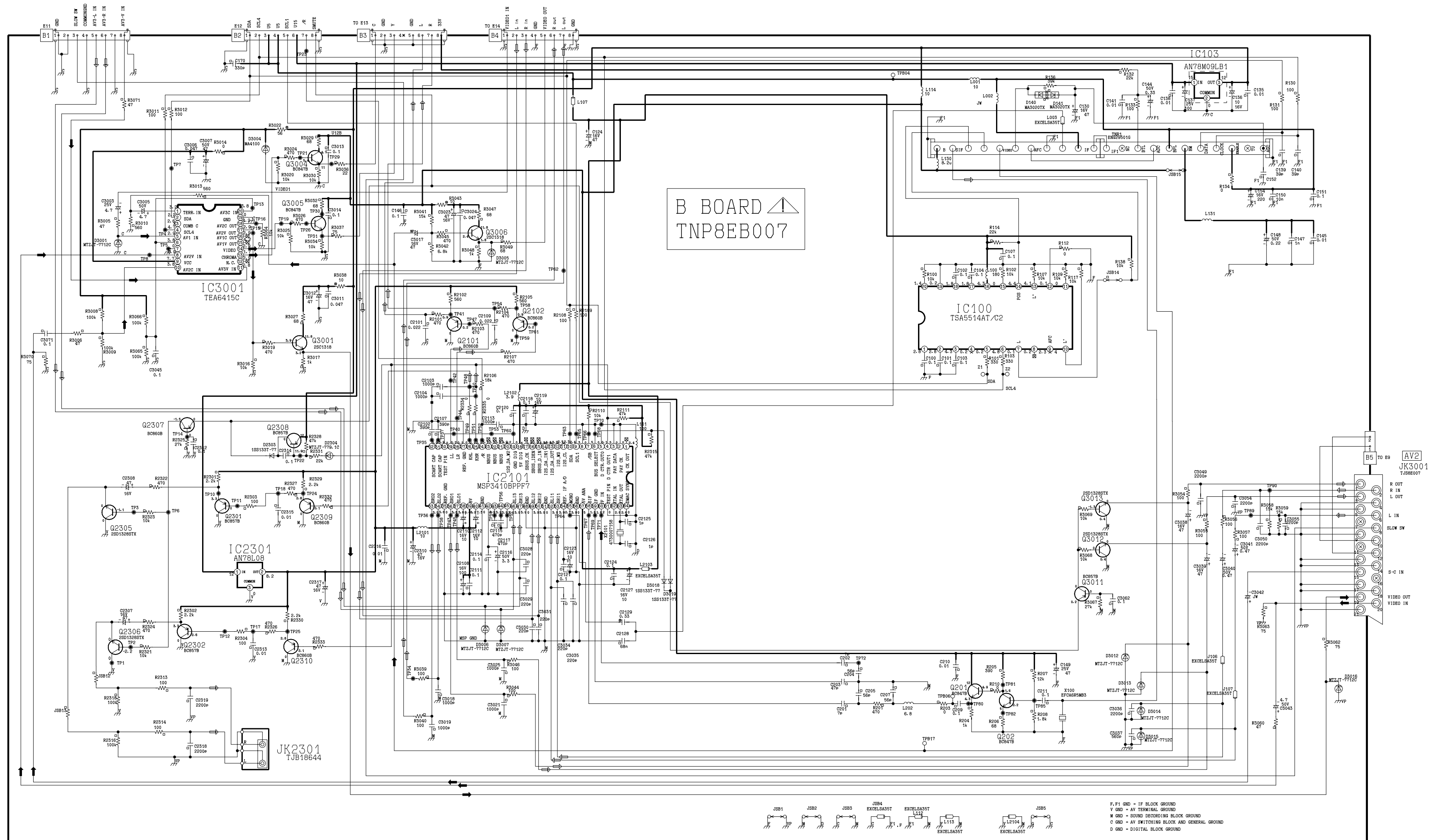

E-BOARD TX-28MD3F

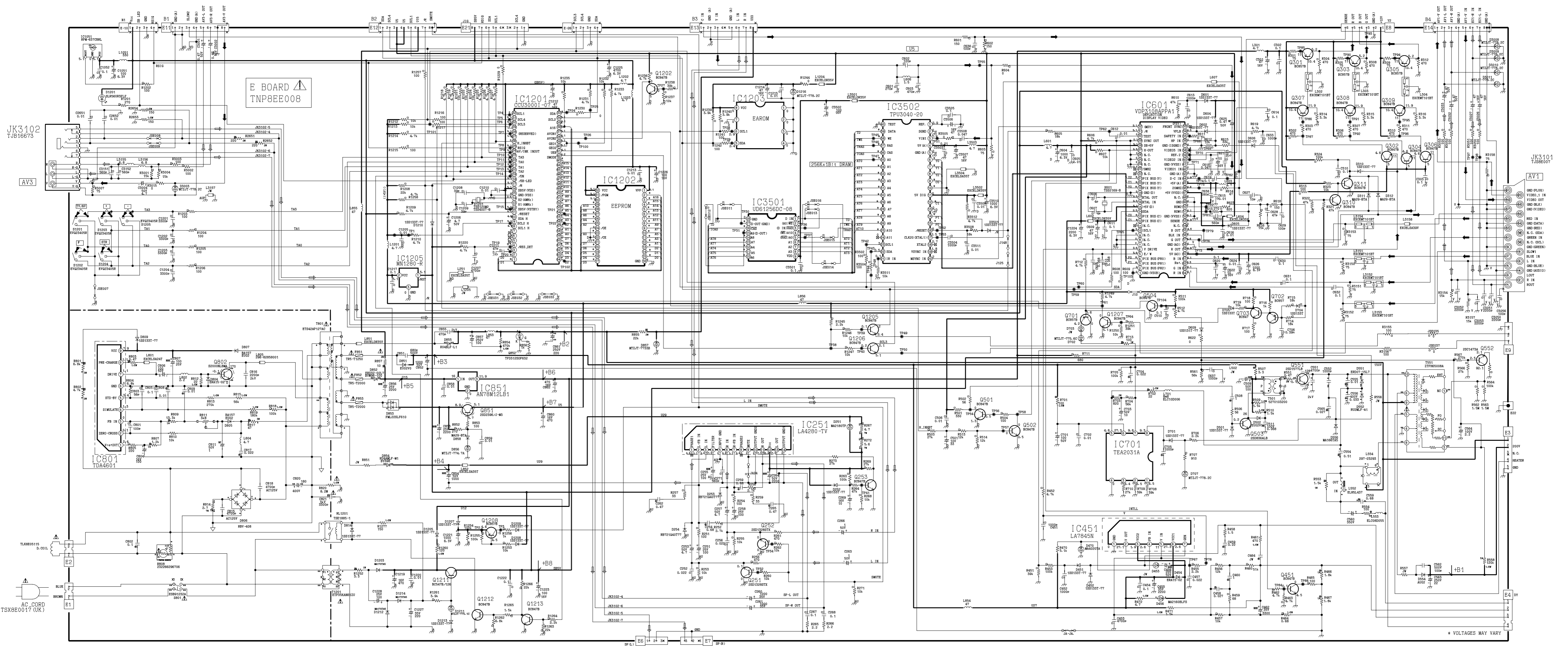

* VOLTAGES MAY VARY

E-BOARD TX-25MD3F

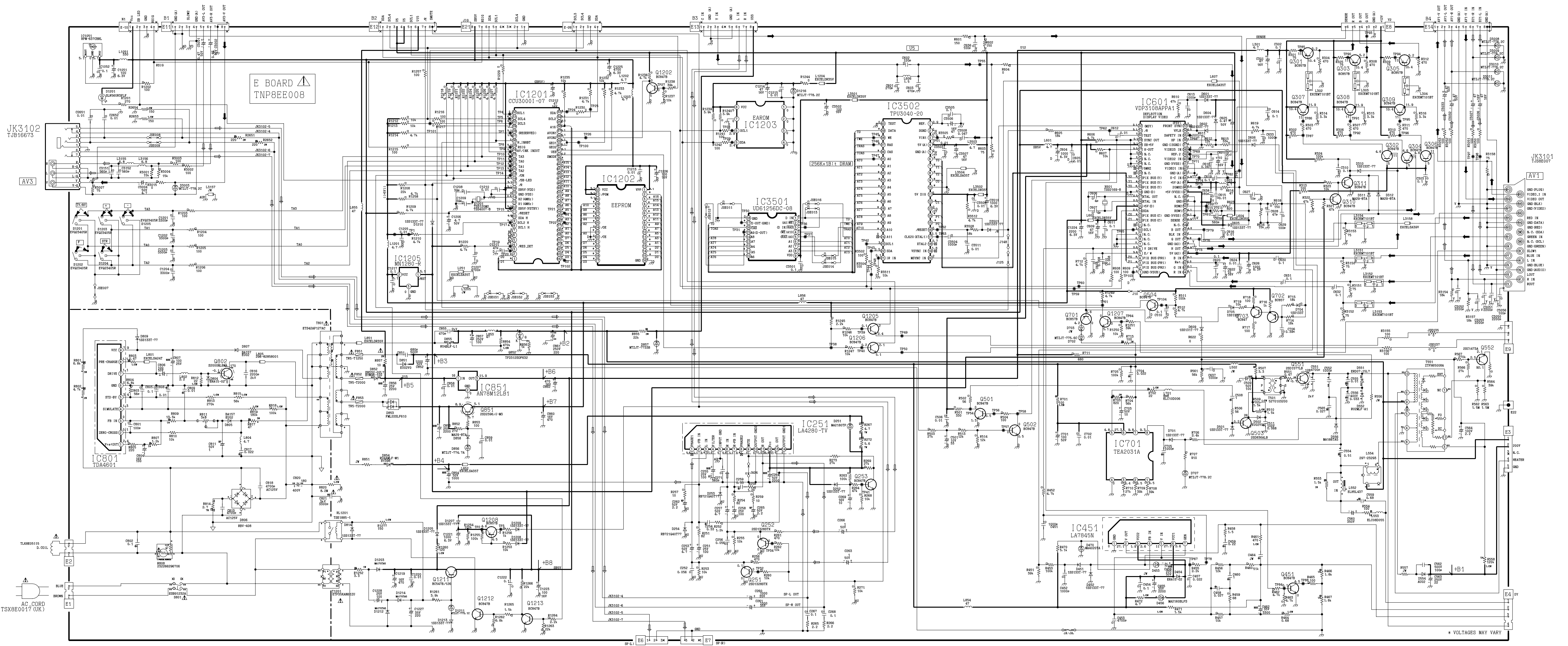

E-BOARD TX-21MD3F

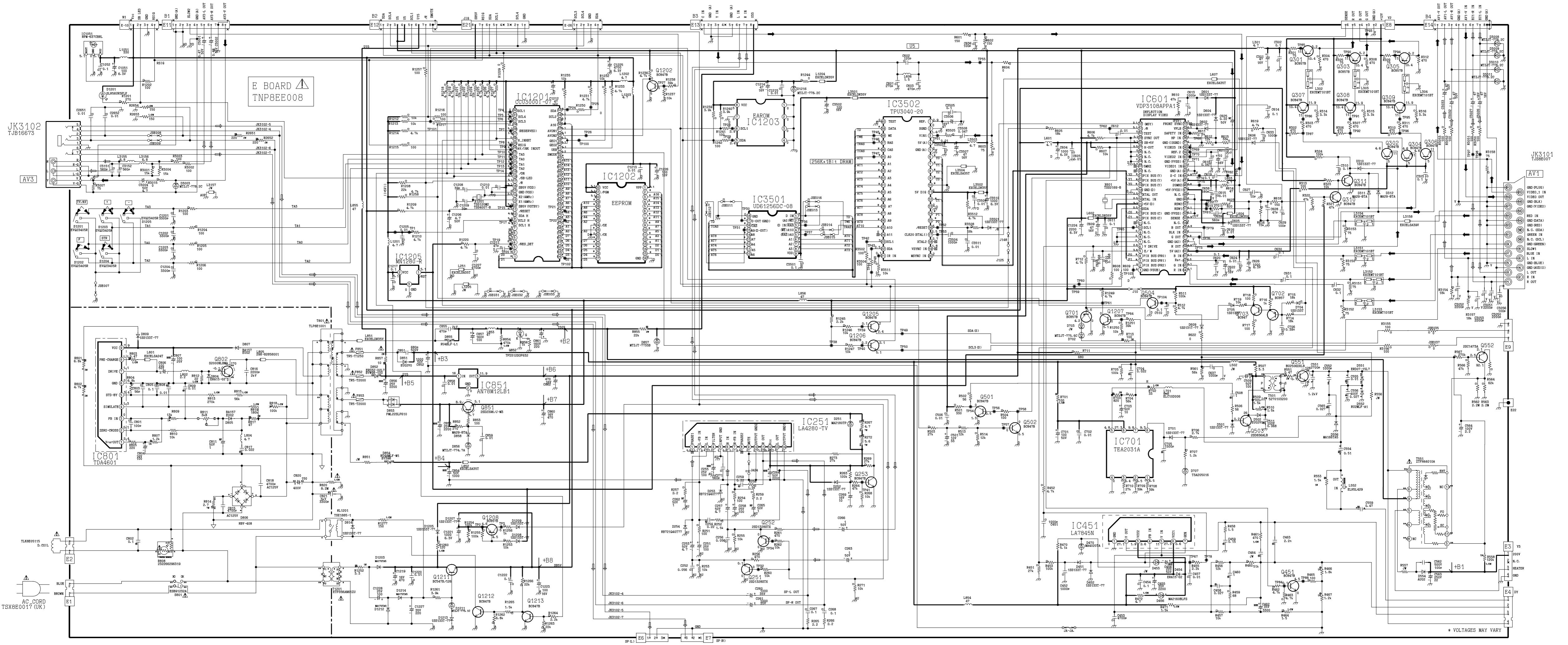

P-BOARD TX-28MD3F / TX-25MD3F / TX-21MD3F

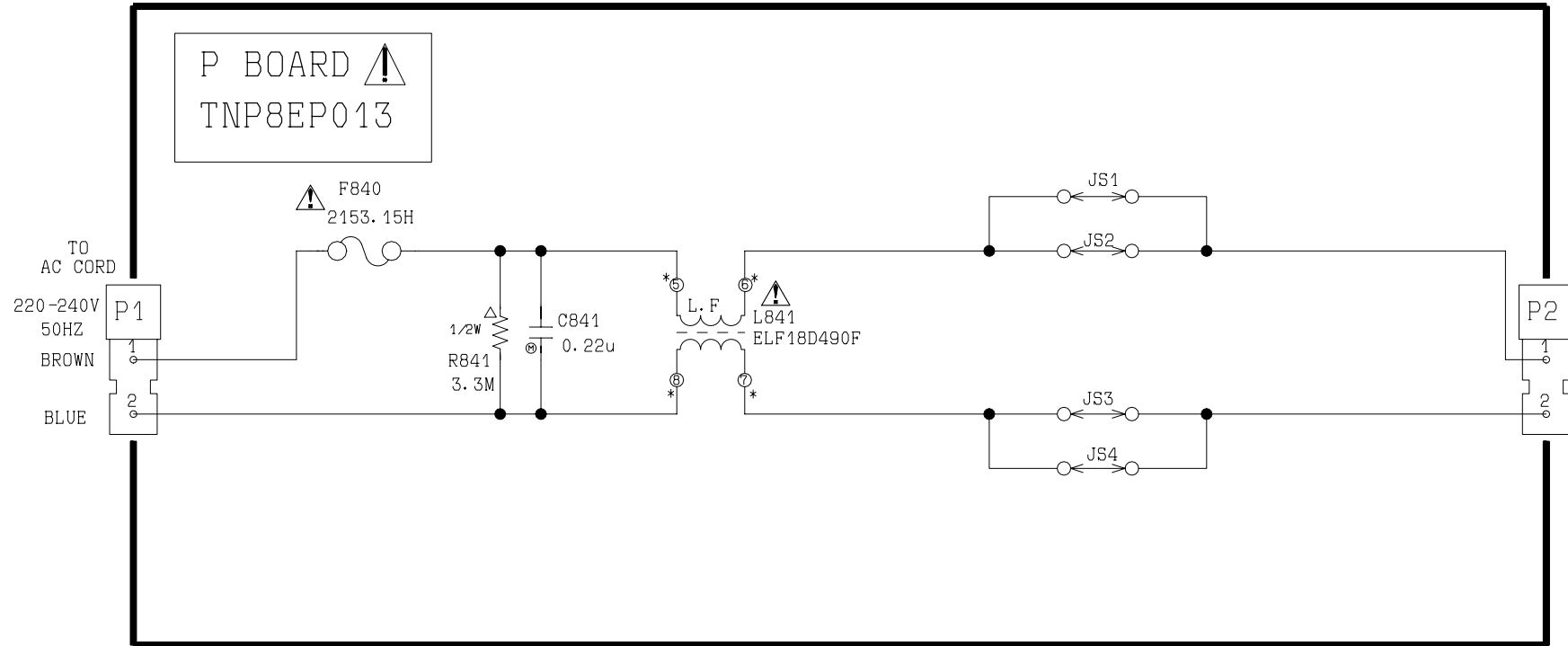

Y-BOARD TX-28MD3F / TX-25MD3F

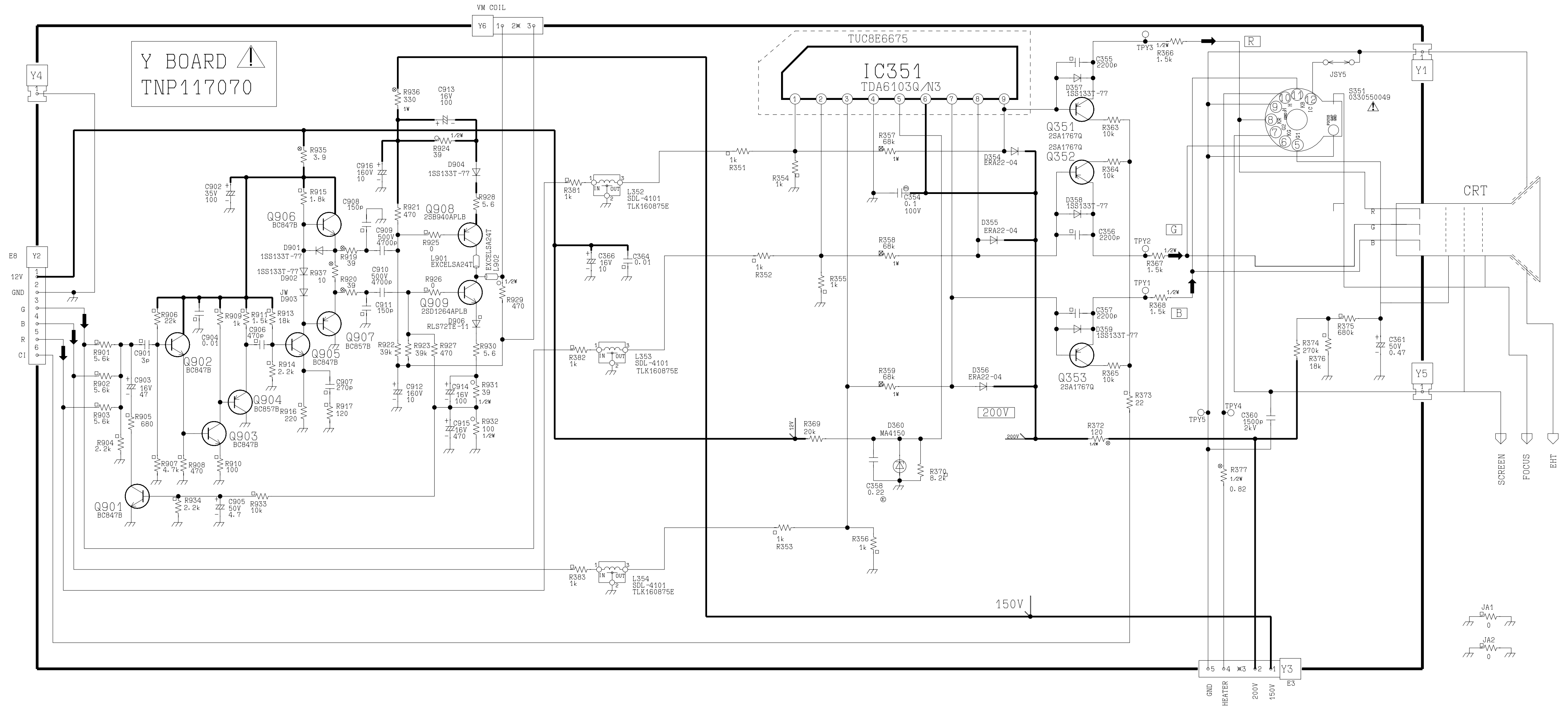

Y-BOARD TX-21MD3F

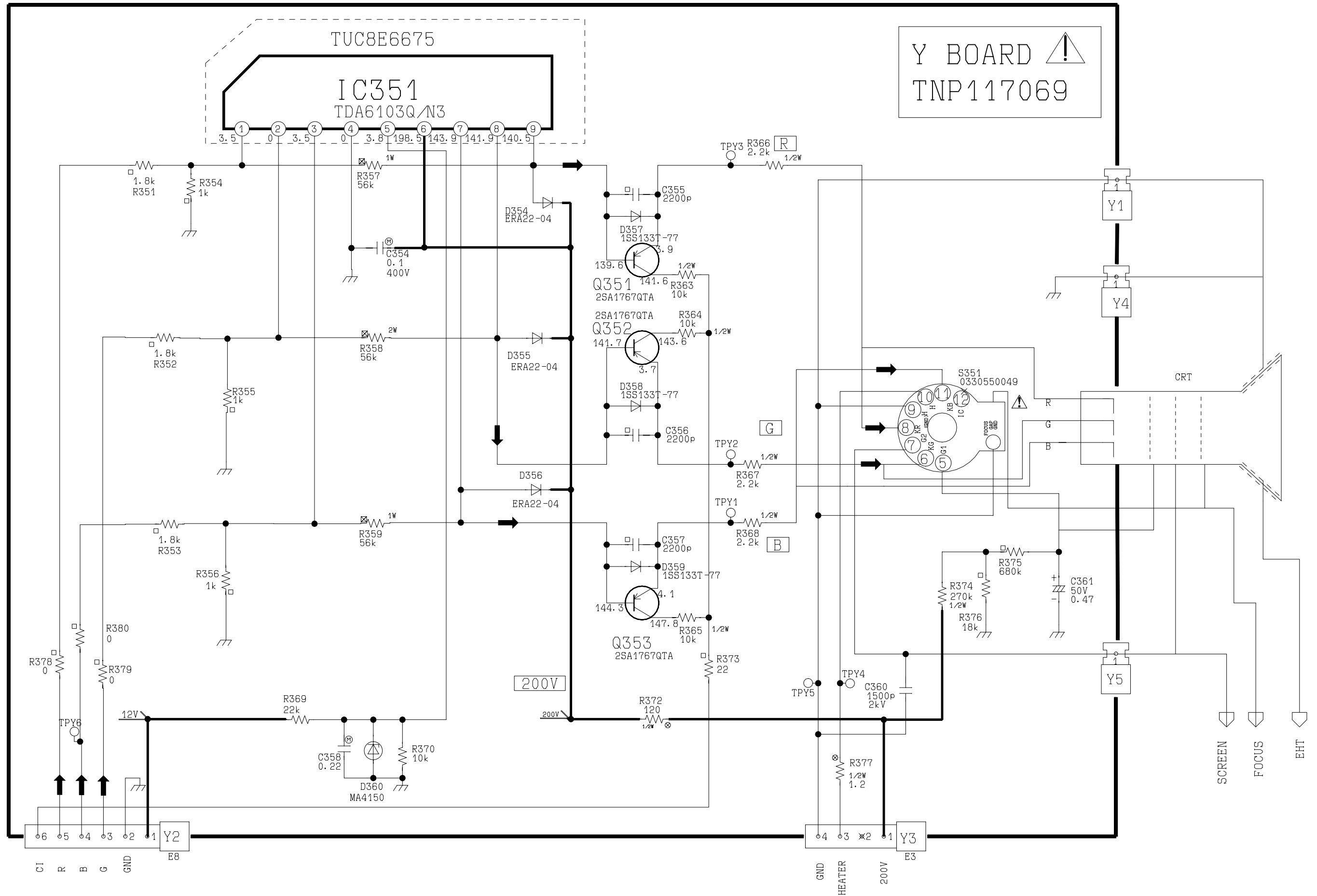

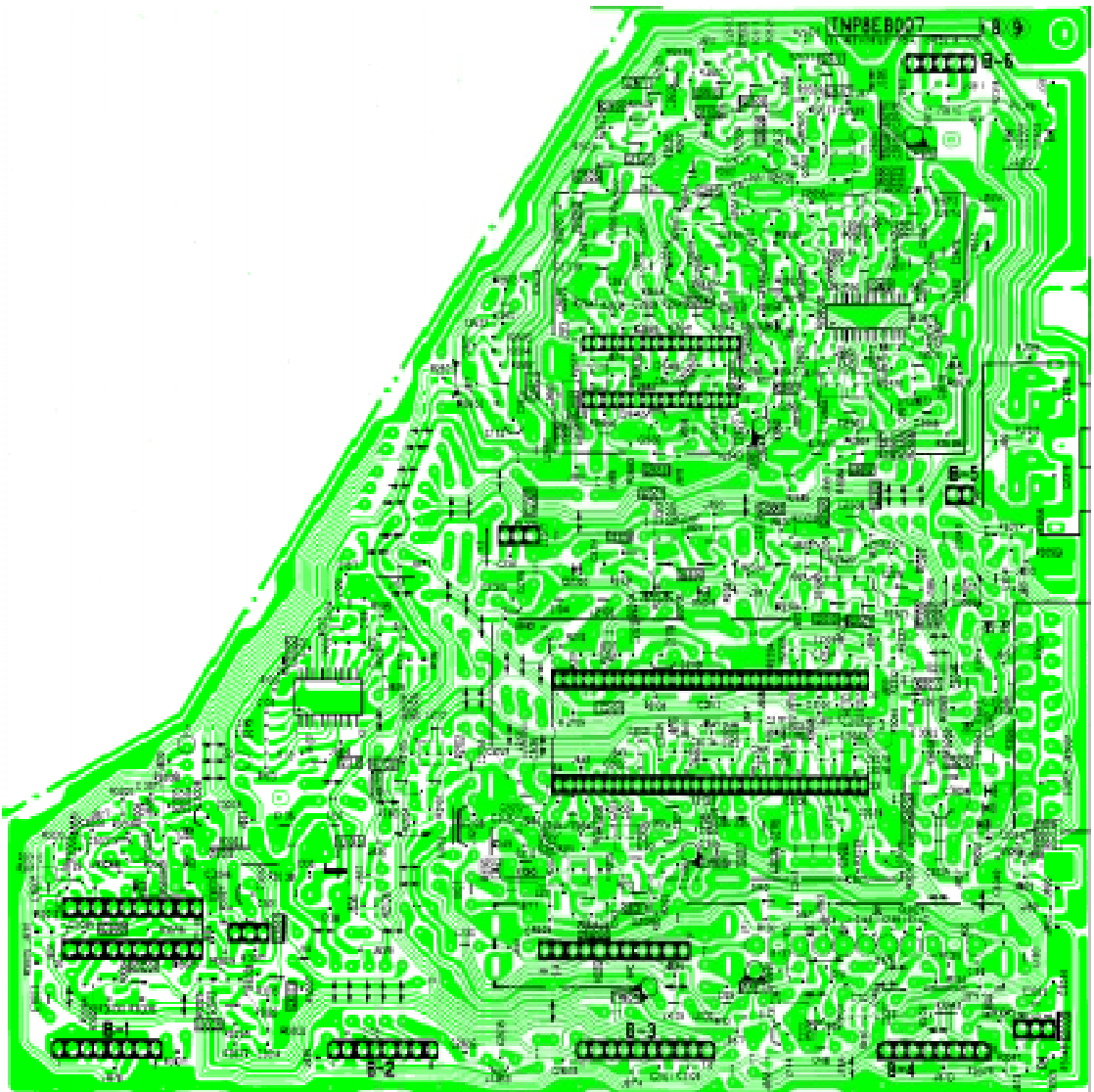

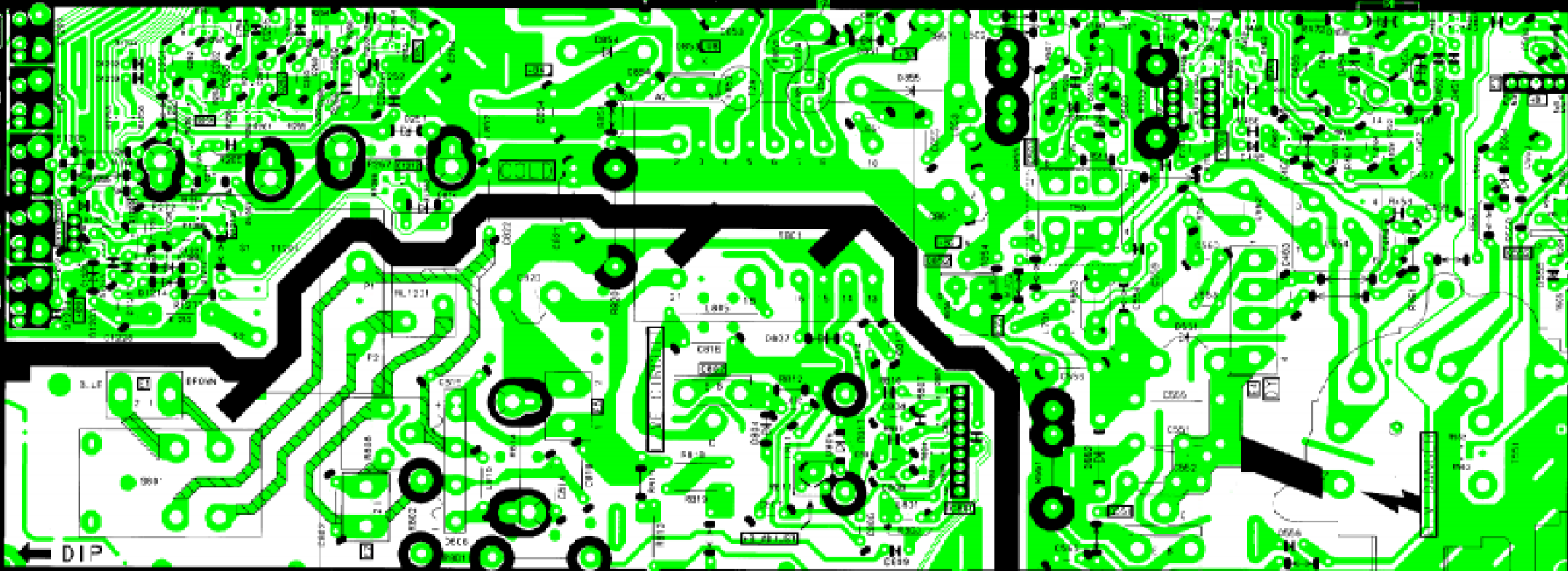
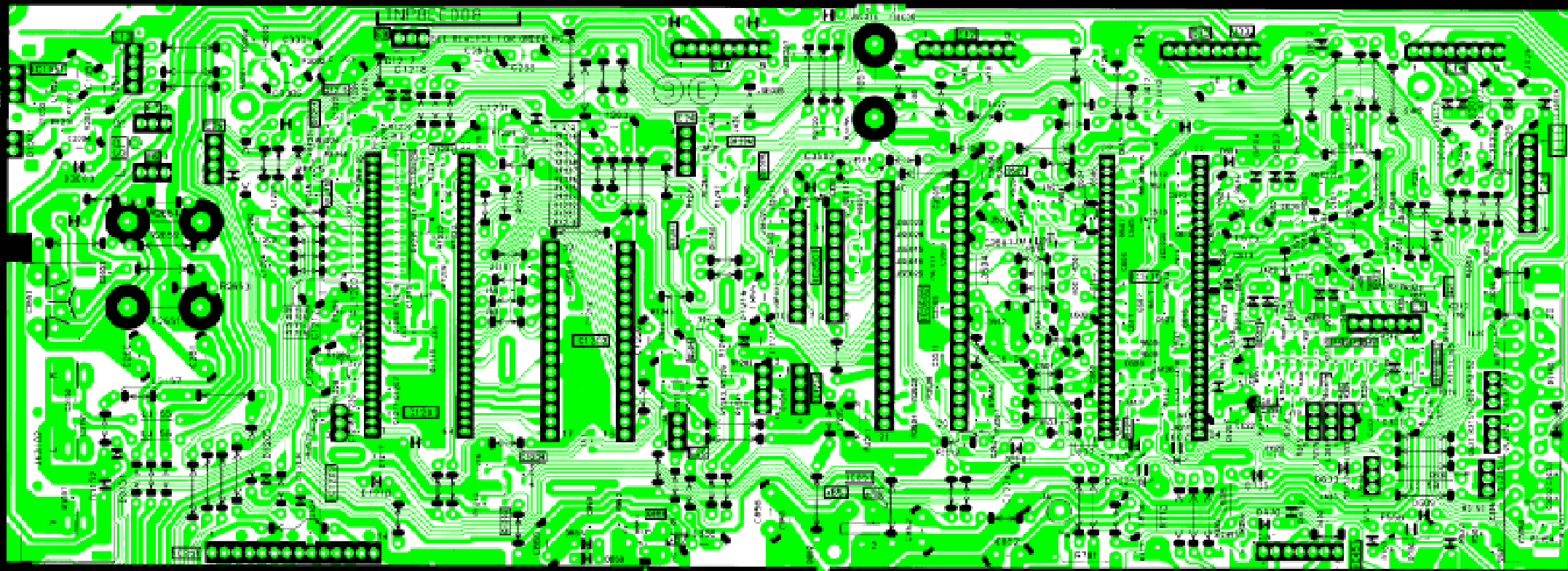

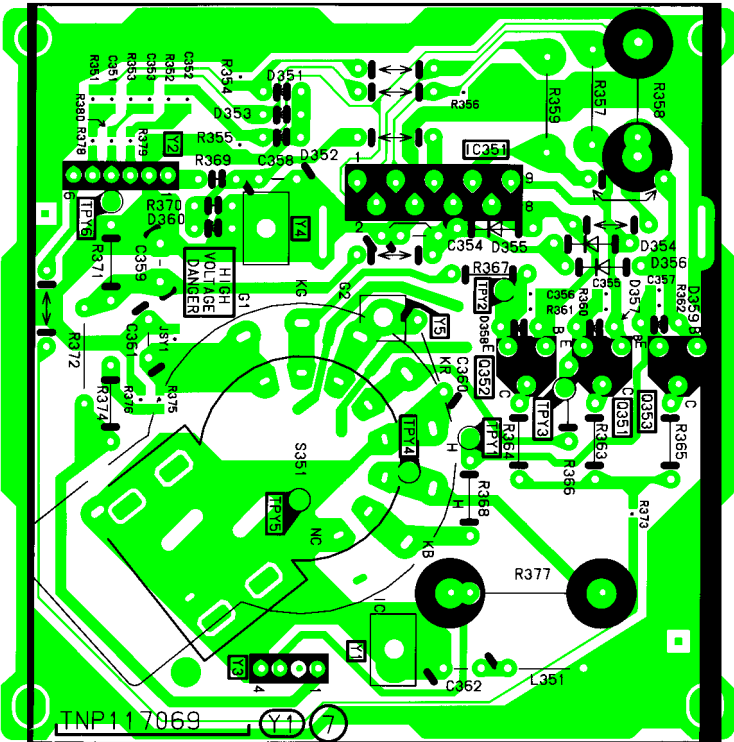

HIGH
VOLTAGE
DANGER

INP117069

Y1 7

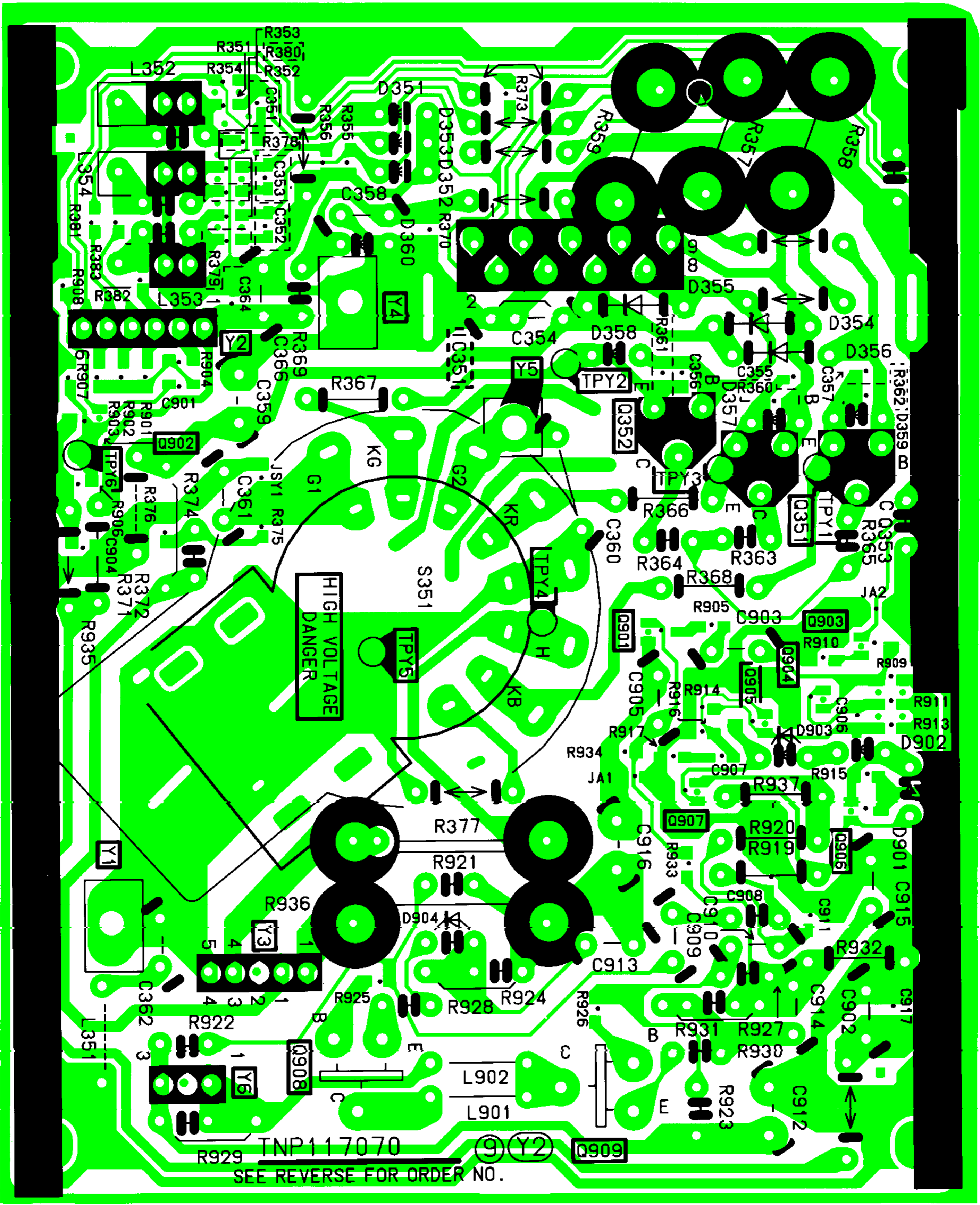

**HIGH VOLTAGE
DANGER**

R929 TNP117070

SEE REVERSE FOR ORDER NO.

9 (Y2)

Q909